

Florentin Smarandache

**NEW RELATIVISTIC PARADOXES
AND OPEN QUESTIONS**

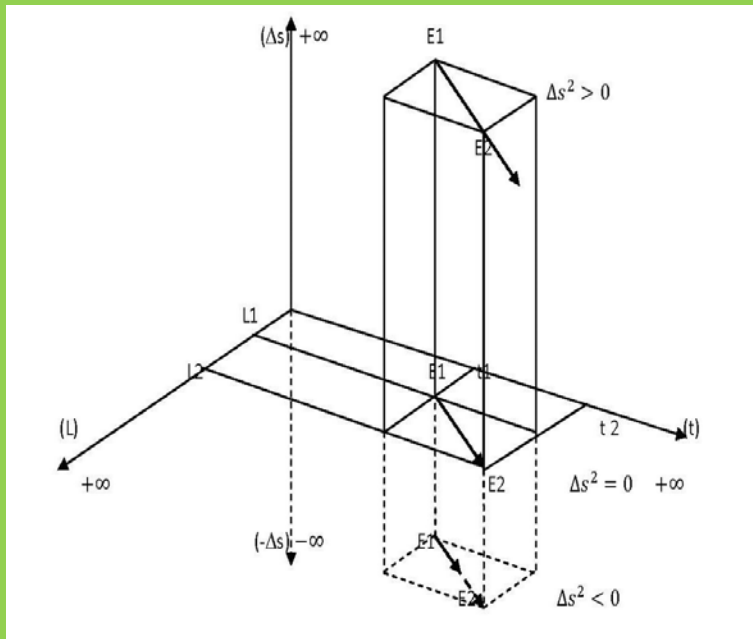

**SOCIETE MAROCAINE
D'IMPRESSION ET D'EQUIPEMENT S.A.R.L**

SOMIPRESS

Siège Sociale : 72, Boulevard Hassan II

Tél. : 238-68 - FES (v. n.)

Florentin Smarandache

**NEW RELATIVISTIC PARADOXES
AND OPEN QUESTIONS**

***SOCIETE MAROCAINE
D'IMPRESSION ET D'EQUIPEMENT S.A.R.L***

SOMIPRESS

**Siège Sociale : 72, Boulevard Hassan II
Tél. : 238-68 - FES (v. n.)**

L'auteur autorise la reproduction de ces idées à la seule condition de citer son nom et les références du présent ouvrage.

(c) Imprimerie SOMIPRESS, 1983, Edition Anglaise, FES. Tous droits de traduction , de reproduction et d'adaptation réservés pour tous pays.

CONTENTS

Medium Composition and Medium Lensing

(preface): 9

Chapter 1.

Contraction and Dilation Factors in The Special Theory of Relativity: 15

- 1.1. Length-Contraction Factor: 16
- 1.2. Time-Dilation Factor: 16
- 1.3. Oblique-Length Contraction Factor: 18
- 1.4. Angle-Distortion Equations: 22
 - 1.4.1. Calculation of Distorted Angles: 23
 - 1.4.2. Tangential Relations between Distorted Acute Angles vs. Original Acute Angles of a Right Triangle: 25
 - 1.4.3. Recovering the Oblique-Length Contraction Factor Formula in a Different Way: 30
 - 1.4.4. Tangential Relations between Distorted Angles vs. Original Angles of A General Triangle: 32

1.4.5. Other Relations between the Distorted Angles and the Original Angles: 34

Chapter 2.
New Paradoxes for
The Special Theory of Relativity: 38

- 2.1. Rotational Twin Paradox: 39
- 2.2. Space Station Twin Paradox: 40
- 2.3. Both Twins Traveling Paradox: 40
- 2.4. Rocky Planet Paradox: 42
- 2.5. Length Contraction is Independent of Time: 43
- 2.6. Elasticity of Relativistic Rigid Bodies?: 44
- 2.7. Relativistic Masses vs. Absolute Masses: 44
- 2.8. Miraculous Return to the Original Length!: 45
- 2.9. Miraculous Return to the Original Mass!: 45
- 2.10. Symmetry and Asymmetry!: 45
- 2.11. Physical and Non-Physical Time Dilation!: 46
- 2.12. Density Increasing?: 47
- 2.13. The Mass Paradox: 48
- 2.14. Another Superluminal Thought Experiment: 49

Chapter 3.
Other Paradoxes for
The Special Theory of Relativity: 53

- 3.1. Opposite Thought Experiment: 54
- 3.2. Odd Length Contraction: 56
- 3.3. Multi-Rocket Thought Experiment: 57
- 3.4. Two-Rocket Thought Experiment: 58
- 3.5. Multi-Speed Thought Experiment: 60
- 3.6. Dead and Alive Dilemma: 61
- 3.7. Another Dilemma about Length Contraction: 62
- 3.8. The Paradox of Simultaneity: Who is the Killer?: 64
- 3.9. The Dilemma of Simultaneity: 65
- 3.10. Relativity of Simultaneity is Just an Appearance: 67
- 3.11. Minkowski's Spacetime in Heterogeneous Medium: 67
- 3.12. Spacetime Diagram Didn't Take into Account the Medium Composition: 70
- 3.13. The Spacetime-Interval does not Distinguish Between Events' Nature: 70
- 3.14. The Real Meaning of the Spacetime-Interval: 71
- 3.15. Null Sub-Spacetimes: 74
- 3.16. Relative or Absolute?: 76

Chapter 4.
Dilemmas for
The General Theory of Relativity: 77

- 4.1. A) Distinction between Clock and Time: 78
B) Suggested Experiment # 1 with another Type of Clock: 78
- 4.2. Pretended Experiment on Time Dilation: 82
- 4.3. Limited Weak Equivalence Principle: 83
 - A) The Weak Equivalence Principle is not Quite Equivalent at the Macrolevel: 83
 - B) Weak Equivalence Principle at the Quantum Level?: 91
- 4.4. Constant Acceleration is not Equivalent with Heterogeneous Gravity: 91
- 4.5. Other Questions with Respect to the Weak Equivalent Principle: 92
- 4.6. Very Limited Strong Equivalence Principle: 92
- 4.7. Relativity on Rotating Frames: 93
- 4.8. The Paradox of Special vs. General Theory of Relativity: 93
- 4.9. Conflicting of Special vs. General Theory of Relativity: 94
- 4.10. A) Redshift and Blueshift are due to the Medium Composition: 94
B) Suggested Experiment # 2 with different Medium Compositions: 95
- 4.11. Not Gravitational Lensing, but Medium Lensing: 96
- 4.12. Medium's Properties: 97
- 4.13. The Frame Dragging is just the Classical Vortex: 100

Chapter 5.

Open Questions and Remarks: 101

- 5.1. Controller is not Aware: 102
- 5.2. Distorted Bodies: 102
- 5.3. Pure Gravitational Field: 103
- 5.4. Other Pure Fields?: 104
- 5.5. Conservation Law for Gravity?: 104
- 5.6. What Happens to the Curved Space around a Massive Object that has been Destroyed?: 105
- 5.7. What Happens to the Planets that Orbit a Star that has Died?: 106
- 5.8. Is Time an Entity without Beginning and Ending?: 106
- 5.9. Creating Gravity: 107
- 5.10. Not All Physical Laws are the Same in All Inertial Reference Frames: 107
- 5.11. Back in Time?: 108
- 5.12. Wormholes do not Exist in the Real World: 108
- 5.13. Newton's Physics or Einstein's Metaphysics?: 109
- 5.14. Neither $2c$ is a Speed Limit: 110
- 5.15. Subjective Dilation-Time: 110
- 5.16. Subjective Local Time vs. Objective Global Time: 110
- 5.17. Relative vs. Absolute Space and Time: 111
- 5.18. Contraction of the Universe?: 111

- 5.19. The Michelson-Morley Null Experiment was not Quite Null: 112
- 5.20. Variable Speed of Light in Vacuum: 112
- 5.21. Instantaneous Acceleration?: 112
- 5.22. Where the Extra-Mass Comes from?: 113
- 5.23. Space is Not Curved: 114
- 5.24. Black Hole is an Imaginary Cosmic Body: 114
- 5.25. Fact or Mathematical Artifact?: 115
- 5.26. What is the Maximum Discovered Density in the Universe?: 115
- 5.27. Maximum Strongest Fields?: 115
- 5.28. How to Compute the Mass of a Singularity Point?: 116
- 5.29. Mute Body: 117
- 5.30. Travel in Time is Science Fiction: 118
- 5.31. Time Coming to a Halt?: 118
- 5.32. No Wormholes: 119
- 5.33. Escape Velocity: 119
- 5.34. What about more Cosmic Bodies?: 120
- 5.35. No Universe Expansion since Earth is not the Center of the Universe: 120
- 5.36. White Holes?: 122
- 5.37. Scientific Perversity: 123
- 5.38. Comparison of Paradoxes of Many Relativities: 125

Medium Composition and Medium Lensing

Preface

In chapter 1, following the Special Theory of Relativity, we generalize the Lorentz Contraction Factor $C(v)$ to an **Oblique-Contraction Factor** $OC(v, \theta)$, which gives the contraction factor of the lengths moving at an oblique angle with respect to the motion direction. When angle θ is 0 or π one gets $OC(v, \theta) = C(v)$, and when angle θ is $\pi/2$ or $3\pi/2$ one gets $OC(v, \theta) = 1$, i.e. no contraction for lengths perpendicular to the motion direction.

We also prove that relativistic moving bodies are distorted, and we compute the **Angle-Distortion Equations**.

In the chapters 2-5 we show several inconsistencies, contradictions, and anomalies in the Special and General Theories of Relativity:

- the length contraction is independent of time, which is not normal since an object may fly one second or one year and it will shrink with the same factor;
- if rigid bodies are shrunk they should break; also, rigid bodies that shrink in flying are miraculously

brought back to the original length and original mass when they stop!

- for some examples the symmetry of time-dilation is supported, but for others the asymmetry;
- the time-dilation is considered physical for some examples, but non-physical for others;
- if the relativistic mass increases, where the extra-mass comes from?
- there are not only relativistic things, but also absolute things in the universe;
- there exist superluminal particles;
- paradoxes and dilemmas of simultaneity are presented;
- relativity of simultaneity is just an appearance;
- how to study the Relativity on rotating frames?
- Minkowski's spacetime diagram does not distinguish between the events' nature; spacetime is too abstract, artificial and it does not represent our reality;
- We make a distinction between "clock", which is an instrument of measuring time, and "time"; we consider an absolute time as in the *Absolute Theory of Relativity*; we propose a first experiment in the GPS system where the type of clock is changed (its material type and its functioning type), and we expect a different correction factor;

- the equivalent principle is not quite “equivalent” since constant acceleration is not equivalent with heterogeneous gravity;
- a paradox of conflicting between Special vs. General Theory of Relativity;
- the Michelson-Morley Null Experiment was not quite “null”;
- speed of light is variable in vacuum for observers in different moving reference frames;
- not all physical laws are the same in all inertial reference frames;
- the Gravitational Waves have not been discovered;
- Einstein’s Field Equations and Pseudotensor are valid in an imaginary space only;
- to say that time can get to a stop in a black hole is science-fiction;
- time traveling is unreal;
- wormholes do not exist in the real world;
- if the universe is expanding (hence moving) is then the universe contracting according to the Theory of Relativity?
- there is no universe expansion as in Hubble’s Law, since this would have as consequence that the Earth is or is becoming the center of the universe... but the experiments do not show this.

In order to make the distinction between “clock” and “time”, we suggest a **first experiment** with a different type of clock for the GPS clocks, in order to prove that the resulted dilation and contraction factors are different from those obtained with the cesium atomic clock.

We also consider that Not All Physical Laws are the Same in All Inertial Reference Frames, since there are universal constants that are not quite “constant” throughout the universe, and also there are *Different Inertial Values for a Moving Object*. The Laws of Physics are influenced by the frame of reference’s velocity and by the frame of reference’s medium (atmosphere, environment) composition and properties.

We think that the redshift and blueshift are not entirely due to the Doppler’s effect, but also (as in the light bending) to the **Medium Composition** (medium that could be formed by waves, particles, plasma, dust, gaseous, fluids, solids, etc.), to the *medium density gradient*, to the *medium heterogeneity*, and to the *electromagnetic and gravitational fields* contained in that medium, or it could be an **optical phenomenon** (as a stick half in water and half in air looks bended at the water’s surface).

Even the Doppler’s Effect itself is actually an appearance to an Subjective Observer, because the

frequency is the same all over (if one considers the Absolute Observer).

We consider that the space is not curved and the light near massive cosmic bodies bends not because of the gravity only as the General Theory of Relativity asserts (Gravitational Lensing), but because of the **Medium Lensing**.

We also doubt that gravity is only geometry.

Space is not empty as Theory of Relativity asserts, but it is filled with particles, waves, radiations, plasma, gaseous fluids, solids, dust, fields, corpuscles, etc.

Medium Lensing means that photons interact with other particles in the medium. For example, the interaction between a photon of electromagnetic radiation with a charged particle (let's say with a free electron), which is known as *Compton Effect*, produces an increase in the photon's wavelength; and in the *Inverse Compton Effect* the low-energy photons gain energy because they are scattered by much-higher energy free electrons.

Light bends because of the medium gradient and refraction index, similarly as light bends when it leaves or enters a liquid, a plastic, a glass, a quartz, etc. The inhomogeneous medium acts as an optical lens such that its refractive index varies in a fashion, alike the *Gradient-Index Lens*.

The deflection of light near massive cosmic bodies is because of the medium composition (medium that could be formed by various entities), the medium density, the medium heterogeneity, and the

electromagnetic and gravitational fields contained in that medium that light passes through.

This medium, because of all its properties, deviates the light direction.

We propose a **second experiment** to be done by changing the medium's composition elements (particles, fields, etc.), structures, densities, heterogeneities, etc. By changing the medium the light passes through, one should get different degrees of redshifts/blushifts.

Florentin Smarandache

Chapter 1.
Contraction and Dilation Factors in
The Special Theory of Relativity

1.1. Length-Contraction Factor $C(v)$ is just Lorentz Factor:

$$C(v) = \sqrt{1 - \frac{v^2}{c^2}} \in [0,1] \text{ for } v \in [0, c]. \quad (1)$$

$$L = L' \cdot C(v), \quad (2)$$

where L = non-proper length (length contracted),

L' = proper length.

$C(0) = 1$, meaning no space contraction {as in Absolute Theory of Relativity (ATR)}.

$C(c) = 0$, which means according to the Special Theory of Relativity (STR) that if the rocket moves at speed “ c ” then the rocket length and laying down astronaut shrink to zero! This is unrealistic.

1.2. Time-Dilation Factor $D(v)$ is the inverse of Lorentz Factor:

$$D(v) = \frac{1}{\sqrt{1 - \frac{v^2}{c^2}}} \in [1, +\infty] \text{ for } v \in [0, c] \quad (3)$$

$$\Delta t = \Delta t' \cdot D(v) \quad (4)$$

where Δt = non-proper time and

$\Delta t'$ = proper time.

$D(0) = 1$, meaning no time dilation {as in the Absolute Theory of Relativity (ATR)};

$D(c) = \lim_{v \rightarrow c} D(v) = +\infty$, which means

according to the Special Theory of Relativity (STR) that if the rocket moves at speed

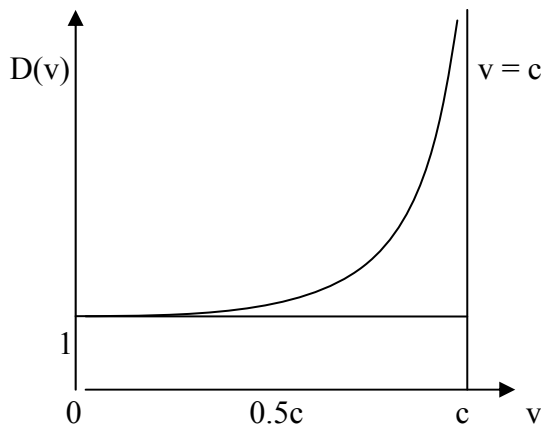

Fig. 1. The Graph of the Time-Dilation Factor

“c” then the observer on earth measures the elapsed non-proper time as infinite, which is unrealistic.

$v = c$ is the equation of the vertical asymptote to the curve of $D(v)$.

1.3. Oblique-Length Contraction Factor

The Special Theory of Relativity asserts that all lengths in the direction of motion are contracted, while the lengths at right angles to the motion are unaffected. But it didn't say anything about lengths at oblique angle to the motion (i.e. neither perpendicular to, nor along the motion direction), how would they behave?

This is a generalization of Galilean Relativity, i.e. we consider the oblique lengths.

The length contraction factor in the motion direction is:

$$C(v) = \sqrt{1 - \frac{v^2}{c^2}}. \quad (5)$$

Suppose we have a rectangular object with width W and length L that travels at a constant speed v with respect to an observer on Earth.

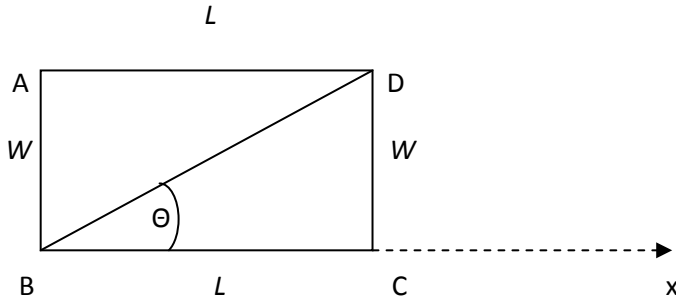

Fig. 2. A Rectangular Object Moving Along the x-Axis

Then its lengths contract and its new dimensions will be L' and W' :

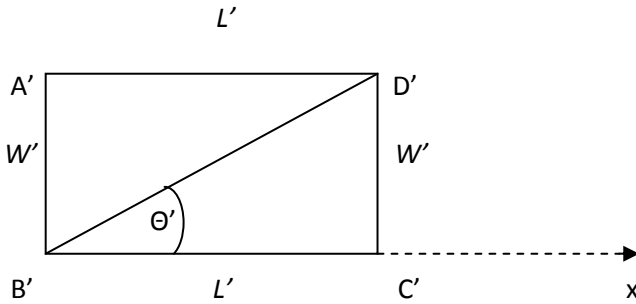

Fig. 3. Contracted Lengths of the Rectangular Object Moving Along the x-Axis

where $L' = L \cdot C(v)$ and $W' = W$.

The initial diagonal of the rectangle $ABCD$ is:

$$\delta = |AC| = |BD| = \sqrt{L^2 + W^2} = \sqrt{L^2 + L^2 \tan^2 \theta} = L \sqrt{1 + \tan^2 \theta} \quad (6)$$

while the contracted diagonal of the rectangle $A'B'C'D'$ is:

$$\begin{aligned}\delta' &= |A'C'| = |B'D'| = \sqrt{(L')^2 + (W')^2} = \\ &= \sqrt{L^2 \cdot C(v)^2 + W^2} = \sqrt{L^2 C(v)^2 + L^2 \tan^2 \theta} = \\ &= L\sqrt{C(v)^2 + \tan^2 \theta}.\end{aligned}\quad (7)$$

Therefore the lengths at oblique angle to the motion are contracted with the oblique factor

$$\begin{aligned}OC(v, \theta) &= \frac{\delta'}{\delta} = \frac{L\sqrt{C(v)^2 + \tan^2 \theta}}{L\sqrt{1 + \tan^2 \theta}} = \sqrt{\frac{C(v)^2 + \tan^2 \theta}{1 + \tan^2 \theta}} \\ &= \sqrt{C(v)^2 \cos^2 \theta + \sin^2 \theta},\end{aligned}\quad (8)$$

which is different from $C(v)$.

$$\delta' = \delta \cdot OC(v, \theta), \text{ where } 0 \leq OC(v, \theta) \leq 1. \quad (9)$$

For unchanged constant speed v , the greater is θ in $(0, \frac{\pi}{2})$ the larger gets the oblique-length contradiction factor, and reciprocally.

By oblique length contraction, the angle

$$\theta \in (0, \frac{\pi}{2}) \cup (\frac{\pi}{2}, \pi) \quad (10)$$

is not conserved.

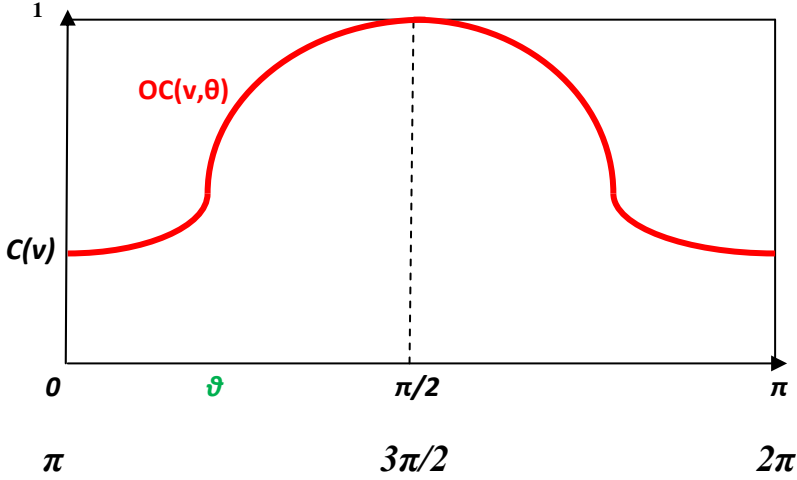

Fig. 4. The Graph of the Oblique-Length Contraction Factor $OC(v, \theta)$

In Fig. 4 the horizontal axis represents the angle θ , while the vertical axis represents the values of the Oblique-Length Contraction Factor $OC(v, \theta)$ for a fixed speed v . Hence $C(v)$ is thus a constant in this graph.

The graph, for v fixed, is periodic of period π , since:

$$\begin{aligned}
 OC(v, \pi + \theta) &= \sqrt{C(v)^2 \cos^2(\pi + \theta) + \sin^2(\pi + \theta)} \\
 &= \sqrt{C(v)^2 [-\cos(\theta)]^2 + [-\sin \theta]^2}
 \end{aligned}$$

$$= \sqrt{C(v)^2 \cos^2 \theta + \sin^2 \theta} = OC(v, \theta). \quad (11)$$

More exactly about the $OC(v, \theta)$ range:

$$OC(v, \theta) \in [C(v), 1], \quad (12)$$

but since $C(v) \in [0, 1]$, one has:

$$OC(v, \theta) \in [0, 1]. \quad (13)$$

The Oblique-Length Contractor

$$OC(v, \theta) = \sqrt{C(v)^2 \cos^2 \theta + \sin^2 \theta} \quad (14)$$

is a generalization of Lorentz Contractor $C(v)$, because:

when $\theta = 0$, or the length is moving along the motion direction, then $OC(v, 0) = C(v)$. Similarly

$$OC(v, \pi) = OC(v, 2\pi) = C(v). \quad (15)$$

Also, if $\theta = \pi/2$, or the length is perpendicular on the motion direction, then $OC(v, \pi/2) = 1$, i.e. no

contraction occurs. Similarly $OC\left(v, \frac{3\pi}{2}\right) = 1$. (16)

1.4. Angle-Distortion Equations

Except for the right angles $\{\pi/2, 3\pi/2\}$ and for the angles $\{0, \pi, 2\pi\}$, all other angles are distorted by the Lorentz transform.

1.4.1. Calculation of Distorted Angles

Let's consider an object of triangular form moving in the direction of its bottom base (on the x -axis), with speed v , as below:

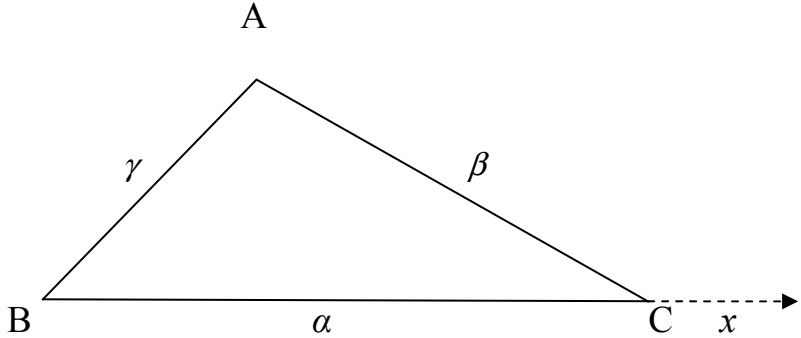

Fig. 5

The side $|BC| = \alpha$ is contracted with the contraction factor $C(v)$ since BC is moving along the motion direction, therefore $|B'C'| = \alpha \cdot C(v)$. (17)

But the oblique sides AB and CA are contracted respectively with the oblique-contraction factors $OC(v, \sphericalangle B)$ and $OC(v, \pi - \sphericalangle C)$, where $\sphericalangle B$ means angle B :

$$|A'B'| = \gamma \cdot OC(v, \sphericalangle B) \quad (18)$$

$$\text{and } |C'A'| = \beta \cdot OC(v, \pi - \sphericalangle C) = \beta \cdot OC(v, \sphericalangle A + \sphericalangle B), \quad (19)$$

since $\sphericalangle A + \sphericalangle B + \sphericalangle C = \pi$.

Triangle ABC is shrunk and distorted to $A'B'C'$ as below:

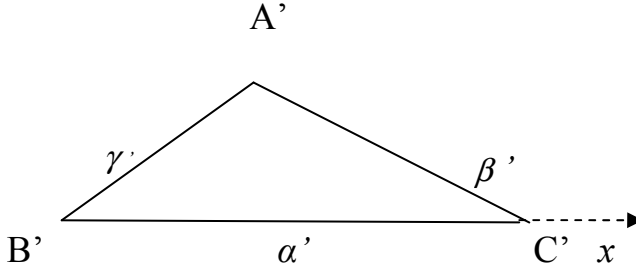

Fig. 6

Hence one gets:

$$\alpha' = \alpha \cdot C(v) \quad (20)$$

$$\beta' = \beta \cdot OC(v, \sphericalangle A + \sphericalangle B) \quad (21)$$

$$\gamma' = \gamma \cdot OC(v, \sphericalangle B) \quad (22)$$

In the resulting triangle $A'B'C'$, since one knows all its side lengths, one applies the Law of Cosine in order to find each angle $\sphericalangle A'$, $\sphericalangle B'$, and $\sphericalangle C'$.

Therefore:

$$\sphericalangle A' = \arccos \frac{-\alpha'^2 \cdot C(v)^2 + \beta'^2 \cdot OC(v, \sphericalangle A + \sphericalangle B)^2 + \gamma'^2 \cdot OC(v, \sphericalangle B)^2}{2\beta' \cdot \gamma' \cdot OC(v, \sphericalangle B) \cdot OC(v, \sphericalangle A + \sphericalangle B)} \quad (23)$$

$$\sphericalangle B' = \arccos \frac{\alpha'^2 \cdot C(v)^2 - \beta'^2 \cdot OC(v, \sphericalangle A + \sphericalangle B)^2 + \gamma'^2 \cdot OC(v, \sphericalangle B)^2}{2\alpha' \cdot \gamma' \cdot C(v) \cdot OC(v, \sphericalangle B)} \quad (24)$$

$$\sphericalangle C' = \arccos \frac{\alpha^2 \cdot C(v)^2 + \beta^2 \cdot OC(v, \sphericalangle A + \sphericalangle B)^2 - \gamma^2 \cdot OC(v, \sphericalangle B)^2}{2\alpha \cdot \beta \cdot C(v) \cdot OC(v, \sphericalangle A + \sphericalangle B)} \quad (25)$$

As we can see, the angles $\sphericalangle A'$, $\sphericalangle B'$, and $\sphericalangle C'$ are, in general, different from the original angles $\sphericalangle A$, $\sphericalangle B$, and $\sphericalangle C$ respectively.

The distortion of an angle is, in general, different from the distortion of another angle.

1.4.2. Tangential Relations between Distorted Acute Angles vs. Original Acute Angles of a Right Triangle

Let's consider a right triangle with one of its legs along the motion direction.

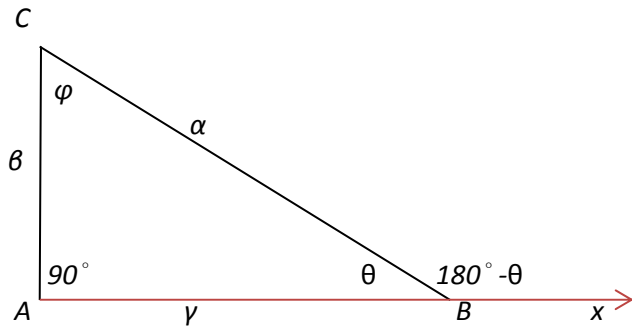

Fig. 7

$$\tan \theta = \frac{\beta}{\gamma} \quad (26)$$

$$\tan(180^\circ - \theta) = -\tan \theta = -\frac{\beta}{\gamma}. \quad (27)$$

After contraction of the side AB (and consequently contraction of the oblique side BC) one gets:

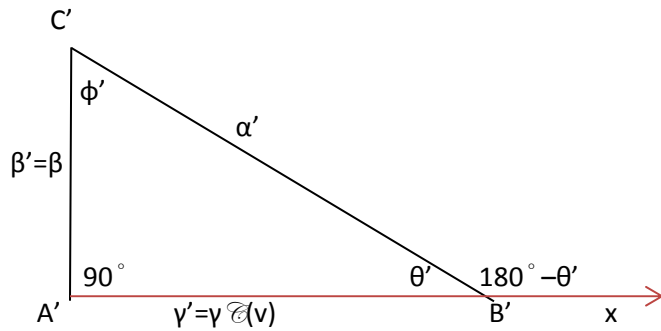

Fig. 8

$$\tan(180^\circ - \theta') = -\tan \theta' = -\frac{\beta'}{\gamma'} = -\frac{\beta}{\gamma \gamma(v)} \quad (28)$$

Then:

$$\frac{\tan(180^\circ - \theta')}{\tan(180^\circ - \theta)} = \frac{-\frac{\beta}{\gamma \mathcal{C}(v)}}{-\frac{\beta}{\gamma}} = -\frac{\beta}{\gamma \mathcal{C}(v)} \left(-\frac{\gamma}{\beta} \right) = \frac{1}{\mathcal{C}(v)} \quad (29)$$

Therefore

$$\tan(\pi - \theta') = \frac{\tan(\pi - \theta)}{\mathcal{C}(v)} \quad (30)$$

and consequently

$$\tan \theta' = \frac{\tan \theta}{\mathcal{C}(v)} \quad (31)$$

or

$$\tan B' = \frac{\tan B}{\mathcal{C}(v)} \quad (32)$$

which is the Angle Distortion Equation, where θ is the angle formed by a side travelling along the motion direction and another side which is oblique on the motion direction.

The angle θ is increased {i.e. $\theta' > \theta$ }.

$$\tan \varphi = \frac{\gamma}{\beta} \quad \text{and} \quad \tan \varphi' = \frac{\gamma'}{\beta'} = \frac{\gamma \mathcal{C}(v)}{\beta} \quad (33)$$

whence:

$$\frac{\tan \varphi'}{\tan \varphi} = \frac{\frac{\gamma \mathcal{C}(v)}{\beta}}{\frac{\gamma}{\beta}} = \frac{\gamma \mathcal{C}(v)}{\beta} \cdot \frac{\beta}{\gamma} = \mathcal{C}(v) \quad (34)$$

So we get the following Angle Distortion Equation:

$$\tan \varphi' = \tan \varphi \cdot \mathcal{E}(v) \quad (35)$$

or

$$\tan C' = \tan C \cdot \mathcal{E}(v) \quad (36)$$

where φ is the angle formed by one side which is perpendicular on the motion direction and the other one is oblique to the motion direction.

The angle φ is decreased (i.e. $\varphi' < \varphi$).

If the traveling right triangle is oriented the opposite way

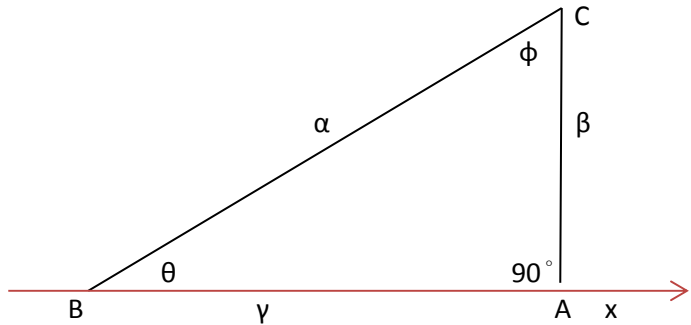

Fig. 9

$$\tan \theta = \frac{\beta}{\gamma} \quad \text{and} \quad \tan \varphi = \frac{\gamma}{\beta} \quad (37)$$

Similarly, after contraction of side AB (and consequently contraction of the oblique side BC) one gets

$$\tan \theta' = \frac{\beta'}{\gamma'} = \frac{\beta}{\gamma \mathcal{E}(v)} \quad (38)$$

and

$$\tan \varphi' = \frac{\gamma'}{\beta'} = \frac{\gamma \mathcal{E}(v)}{\beta} \quad (39)$$

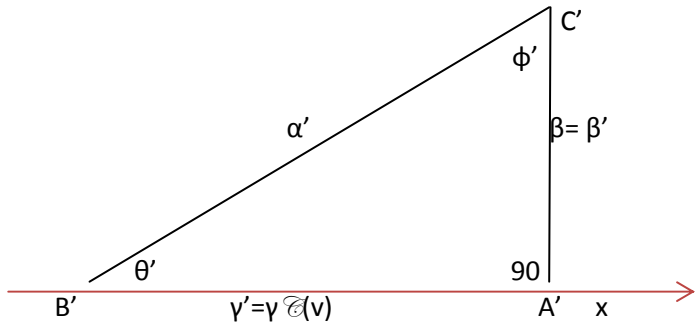

Fig. 10

$$\frac{\tan \theta'}{\tan \theta} = \frac{\frac{\beta}{\gamma \mathcal{E}(v)}}{\frac{\beta}{\gamma}} = \frac{1}{\mathcal{E}(v)} \quad (40)$$

or

$$\tan \theta' = \frac{\tan \theta}{\mathcal{E}(v)} \quad (41)$$

and similarly

$$\frac{\tan \varphi'}{\tan \varphi} = \frac{\frac{\gamma \mathcal{E}(v)}{\beta}}{\frac{\gamma}{\beta}} = \mathcal{E}(v) \quad (42)$$

or

$$\tan \varphi' = \tan \varphi \cdot \mathcal{C}(v) \quad (43)$$

Therefore one got the same Angle Distortion Equations for a right triangle traveling with one of its legs along the motion direction.

1.4.3. Recovering the Oblique-Length Contraction Factor Formula in a Different Way

From

$$\sin \theta = \frac{\beta}{\alpha}, \text{ whence } \alpha = \frac{\beta}{\sin \theta} \quad (44)$$

and

$$\sin \theta' = \frac{\beta'}{\alpha'} = \frac{\beta}{\alpha'}, \text{ whence } \alpha' = \frac{\beta}{\sin \theta'} \quad (45)$$

one has

$$\frac{\alpha'}{\alpha} = \frac{\frac{\beta}{\sin \theta'}}{\frac{\beta}{\sin \theta}} = \frac{\sin \theta}{\sin \theta'}. \quad (46)$$

Because

$$\tan^2 x + 1 = \frac{1}{\cos^2 x} = \frac{1}{1 - \sin^2 x} \quad (47)$$

then

$$\frac{\tan^2 x + 1}{1} = \frac{1}{1 - \sin^2 x} \quad (48)$$

or

$$1 - \sin^2 x = \frac{1}{\tan^2 x + 1} \quad (49)$$

or

$$\sin^2 x = -\frac{1}{\tan^2 x + 1} + 1 \quad (50)$$

$$\sin^2 x = \frac{\tan^2 x}{\tan^2 x + 1} \quad (51)$$

One then gets

$$\left(\frac{\alpha'}{\alpha}\right)^2 = \frac{\frac{\tan^2 \theta}{\tan^2 \theta + 1}}{\frac{\tan^2 \theta'}{\tan^2 \theta' + 1}} = \frac{\frac{\tan^2 \theta}{\tan^2 \theta + 1}}{\frac{\tan^2 \theta}{\mathcal{C}(v)^2}} = \frac{\tan^2 \theta}{\tan^2 \theta + 1} \div \left[\frac{\tan^2 \theta}{\mathcal{C}(v)^2} \div \frac{\tan^2 \theta + \mathcal{C}(v)^2}{\mathcal{C}(v)^2} \right] =$$

$$\frac{\tan^2 \theta}{\tan^2 \theta + 1} \cdot \frac{\tan^2 \theta + \mathcal{C}(v)^2}{\tan^2 \theta} = \frac{\tan^2 \theta + \mathcal{C}(v)^2}{\tan^2 \theta + 1} = \frac{\tan^2 \theta + \mathcal{C}(v)^2}{\frac{1}{\cos^2 \theta}} =$$

$$= \sin^2 \theta + \cos^2 \theta \mathcal{C}(v)^2 = \mathcal{C}(v)^2 \cos^2 \theta + \sin^2 \theta. \quad (52)$$

Whence

$$\frac{\alpha'}{\alpha} = \sqrt{\mathcal{C}(v)^2 \cos^2 \theta + \sin^2 \theta} \quad (53)$$

hence the same result as in section 1.3:

$$\mathcal{O}\mathcal{C}(v, \theta) = \sqrt{\mathcal{C}(v)^2 \cos^2 \theta + \sin^2 \theta}. \quad (54)$$

1.4.4. Tangential Relations between Distorted Angles vs. Original Angles of A General Triangle

Let's suppose a general triangle $\triangle ABC$ is travelling at speed v along the side BC as bellow

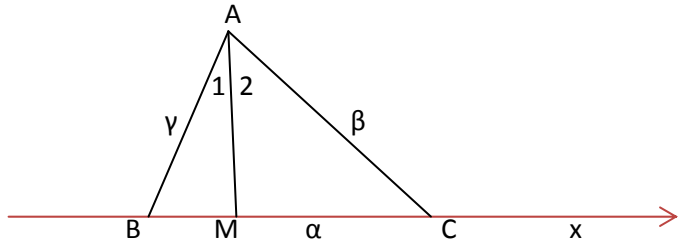

Fig. 11

The height remains not contracted: $AM \equiv A'M'$.

We can split this figure into two traveling right sub-triangles as bellow:

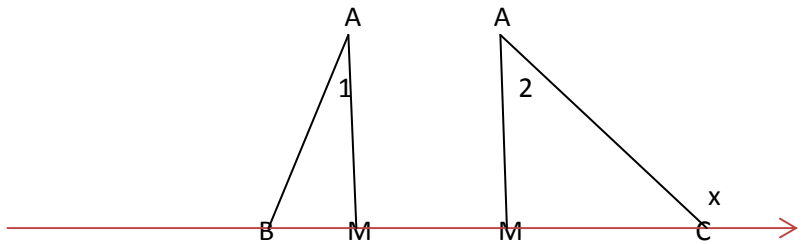

Fig. 12

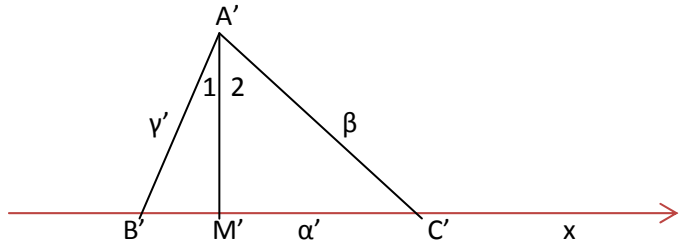

Fig. 13

Similarly we can split this figure into two traveling right sub-triangles as below:

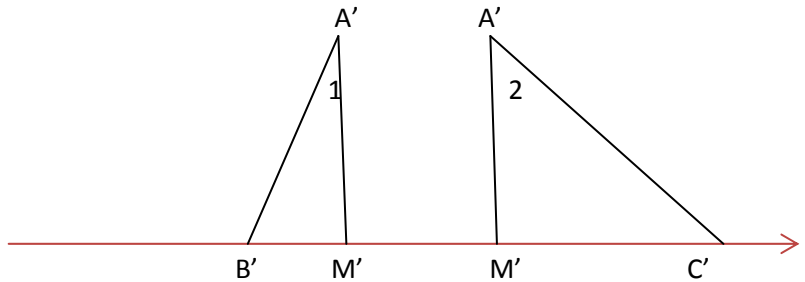

Fig. 14

In the right triangles $\Delta A'M'B'$ and respectively $\Delta A'M'C'$ one has

$$\tan B' = \frac{\tan B}{\mathcal{E}(v)} \text{ and } \tan C' = \frac{\tan C}{\mathcal{E}(v)} \quad (55)$$

Also

$$\tan A'_1 = \tan A_1 \mathcal{E}(v) \text{ and } \tan A'_2 = \tan A_2 \mathcal{E}(v) \quad (56)$$

But

$$\begin{aligned}
\tan A' &= \tan(A_1' + A_2') = \frac{\tan A_1' + \tan A_2'}{1 - \tan A_1' \tan A_2'} = \frac{\tan A_1 \mathcal{E}(v) + \tan A_2 \mathcal{E}(v)}{1 - \tan A_1 \mathcal{E}(v) \tan A_2 \mathcal{E}(v)} = \\
&= \mathcal{E}(v) \cdot \frac{\tan A_1 + \tan A_2}{1 - \tan A_1 \tan A_2 \mathcal{E}(v)^2} = \\
&= \mathcal{E}(v) \cdot \frac{\frac{\tan A_1 + \tan A_2}{1 - \tan A_1 \tan A_2} \cdot (1 - \tan A_1 \tan A_2)}{1 - \tan A_1 \tan A_2 \cdot \mathcal{E}(v)^2} = \\
&= \mathcal{E}(v) \cdot \frac{\tan(A_1 + A_2)}{1} \cdot \frac{1 - \tan A_1 \tan A_2}{1 - \tan A_1 \tan A_2 \mathcal{E}(v)^2} = \\
&= \mathcal{E}(v) \cdot \tan A \cdot \frac{1 - \tan A_1 \tan A_2}{1 - \tan A_1 \tan A_2 \mathcal{E}(v)^2}.
\end{aligned} \tag{57}$$

We got

$$\tan A' = \tan A \cdot \mathcal{E}(v) \cdot \frac{1 - \tan A_1 \tan A_2}{1 - \tan A_1 \tan A_2 \mathcal{E}(v)^2} \tag{58}$$

1.4.5. Other Relations between the Distorted Angles and the Original Angles

A) Another relation uses the Law of Sines in the triangles $\triangle ABC$ and respectively $\triangle A'B'C'$:

$$\frac{\alpha}{\sin A} = \frac{\beta}{\sin B} = \frac{\gamma}{\sin C} \tag{59}$$

$$\frac{\alpha'}{\sin A'} = \frac{\beta'}{\sin B'} = \frac{\gamma'}{\sin C'} \quad (60)$$

After substituting

$$\alpha' = \alpha \mathcal{O}(\nu) \quad (61)$$

$$\beta' = \beta \mathcal{O}(\nu, C) \quad (62)$$

$$\gamma' = \gamma \mathcal{O}(\nu, B) \quad (63)$$

into the second relation one gets:

$$\frac{\alpha \mathcal{O}(\nu)}{\sin A'} = \frac{\beta \mathcal{O}(\nu, C)}{\sin B'} = \frac{\gamma \mathcal{O}(\nu, B)}{\sin C'} \quad (64)$$

Then we divide term by term the previous equalities:

$$\frac{\frac{\alpha}{\sin A}}{\alpha \mathcal{O}(\nu)} = \frac{\frac{\beta}{\sin B}}{\beta \mathcal{O}(\nu, C)} = \frac{\frac{\gamma}{\sin C}}{\gamma \mathcal{O}(\nu, B)} \quad (65)$$

whence one has:

$$\frac{\sin A'}{\sin A \cdot \mathcal{O}(\nu)} = \frac{\sin B'}{\sin B \cdot \mathcal{O}(\nu, C)} = \frac{\sin C'}{\sin C \cdot \mathcal{O}(\nu, B)} \quad (66)$$

B) Another way:

$$A' = 180^\circ - (B' + C') \text{ and } A = 180^\circ - (B + C) \quad (67)$$

$$\begin{aligned}
\tan A' &= \tan[180^\circ - (B' + C')] = -\tan(B' + C') = -\frac{\tan B' + \tan C'}{1 - \tan B' \tan C'} = \\
&= -\frac{\frac{\tan B}{\mathcal{E}(v)} + \frac{\tan C}{\mathcal{E}(v)}}{1 - \tan B \cdot \tan C / \mathcal{E}(v)^2} = -\frac{1}{\mathcal{E}(v)} \cdot \frac{\tan B + \tan C}{1 - \tan B \cdot \tan C / \mathcal{E}(v)^2} = \\
&= -\frac{\tan(B + C)}{\mathcal{E}(v)} \cdot \frac{1 - \tan B \tan C}{1 - \tan B \tan C / \mathcal{E}(v)^2} = \\
&= -\frac{-\tan[180^\circ - (B + C)]}{\mathcal{E}(v)} \cdot \frac{1 - \tan B \tan C}{1 - \tan B \tan C / \mathcal{E}(v)^2} = \\
&= \frac{\tan A}{\mathcal{E}(v)} \cdot \frac{1 - \tan B \cdot \tan C}{1 - \tan B \cdot \tan C / \mathcal{E}(v)^2} \tag{68}
\end{aligned}$$

We got

$$\tan A' = \frac{\tan A}{\mathcal{E}(v)} \cdot \frac{1 - \tan B \cdot \tan C}{1 - \tan B \cdot \tan C / \mathcal{E}(v)^2} \tag{69}$$

C) Another trigonometric relation.

From the Laws of Cosine in the triangles $\triangle ABC$ and $\triangle A'B'C'$ one gets:

$$\cos A = \frac{-\alpha^2 + \beta^2 + \gamma^2}{2\beta\gamma} \tag{70}$$

and respectively

$$\cos A' = \frac{-\alpha'^2 + \beta'^2 + \gamma'^2}{2\beta'\gamma'} = \frac{-\alpha^2 \cdot \mathcal{C}(v)^2 + \beta^2 \cdot \mathcal{O}\mathcal{C}(v, C)^2 + \gamma^2 \cdot \mathcal{O}\mathcal{C}(v, B)^2}{2\beta \cdot \gamma \cdot \mathcal{O}\mathcal{C}(v, C) \cdot \mathcal{O}\mathcal{C}(v, B)}$$

(71)

that we divide and we obtain

$$\frac{\cos A'}{\cos A} = \frac{-\alpha^2 \cdot \mathcal{C}(v)^2 + \beta^2 \cdot \mathcal{O}\mathcal{C}(v, C)^2 + \gamma^2 \cdot \mathcal{O}\mathcal{C}(v, B)^2}{2\beta \cdot \gamma \cdot \mathcal{O}\mathcal{C}(v, C) \cdot \mathcal{O}\mathcal{C}(v, B)} \cdot \frac{2\beta\gamma}{-\alpha^2 + \beta^2 + \gamma^2}$$

(72)

whence

$$\cos A' = \cos A \cdot \frac{-\alpha^2 \cdot \mathcal{C}(v)^2 + \beta^2 \cdot \mathcal{O}\mathcal{C}(v, C)^2 + \gamma^2 \cdot \mathcal{O}\mathcal{C}(v, B)^2}{(-\alpha^2 + \beta^2 + \gamma^2) \cdot \mathcal{O}\mathcal{C}(v, C) \cdot \mathcal{O}\mathcal{C}(v, B)}$$

(73)

Chapter 2.
New Paradoxes for
The Special Theory of Relativity

2.1. Rotational Twin Paradox

Two twins settle on a massive spherical planet at a train station S . Let's consider that each twin has an accompanying clock, and the two clocks are synchronized. One twin $T1$ remains in the train station, while the other twin $T2$ travels at a uniform high speed with the train around the planet (on the big circle of the planet) until he gets back to the same train station S . Assume the planet is not rotating.

Since the planet is massive, we can consider that on a very small part on its surface the train rail road is linear, so the train is in a linear uniform motion. The larger is the planet's radius the more the rail road approaches a linear trajectory. Because the GPS clocks are alleged to be built on the Theory of Relativity, one can consider the twin $T2$ train's circular trajectory alike the satellite's orbit and one applies the Theory of Relativity. In addition, one assumes the gravitation is the same for the reference frames of $T1$ and $T2$.

Each twin sees the other twin as traveling; therefore each twin finds the other one has aged slower than him. Thus herein we have a relativistic symmetry.

When $T2$ returns to train station S , he finds out that he is younger than $T1$ (therefore asymmetry).

Thus, one gets a contradiction between symmetry and asymmetry.

2.2. Space Station Twin Paradox

Two twins $T1$ and $T2$ synchronize their clocks at the same location L . Then $T2$ travels at relativistic uniform speed to a space station S , where he stops. So far, each twin sees the other one younger, since in each twin inertial reference frame the other twin is moving. The time dilation and length contraction are respectively the same in both inertial reference frames. (There is a forth symmetry.)

Then twin $T2$ return from the space station S to the earth at the location L with a relativistic speed. Again there is a back symmetry since each twin sees the other twin traveling, and again the time dilation and length contraction are respectively the same in both inertial reference frames.

But, when $T2$ returns to earth he finds out that he is younger than $T1$, since $T2$ was traveling while $T1$ didn't. Now there is an asymmetry!

2.3. Both Twins Traveling Paradox

Two twins $T1$ and $T2$ synchronize their clocks at the same location L , then both of them leave with the same uniform high speed v and on the same large distance d on opposite linear directions to the locations A and respectively B (of course $LA = LB = d$) on that planet:

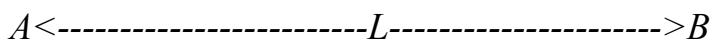

Fig. 15

Each twin sees the other twin moving away from him with the relativistic speed $2v$, so each twin considers the other twin younger than him. The time dilation is the same in both twins' inertial reference frames. Here it is a forth symmetry.

They stop there at A and respectively at B .

Afterwards, the twin $T1$ from A travels on a linear route back to B (passing through L) at a uniform high speed $2v$:

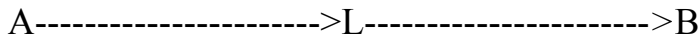

Fig. 16

Again, each twin sees the other twin traveling towards him with a speed $2v$. And again each twin considers the other twin being younger than him, since there is the same time dilation and same length contraction. Again one has a back symmetry.

But, when the twin $T1$ from A gets to B , he finds out that he is younger than the twin $T2$ in B since he has traveled more than $T2$.

2.4. Rocky Planet Paradox

The science tells us that a rocky body in the Solar system whose mass exceeds $3 \cdot 10^{21}$ kg should be round.

The Moon is $7.3 \cdot 10^{22}$ kg, therefore its shape is round. But the Moon rotates around the Earth, therefore it should get flatter in the direction of rotation according to the relativistic length contraction, since the Moon's radius which is perpendicular on the trajectory is unchanged while the Moon's radius in the direction of the motion should get contracted.

Yet, although the Moon orbits the Earth for so long time, it is not flat!

In general, let's consider a rocky non-rotating cosmic body, with mass exceeding $3 \cdot 10^{21}$ kg that orbits the Sun or one of the solar planets. The larger is the cosmic body's orbit, the simpler is to get a small part of its orbit that looks linear. Then this cosmic body should flatten in the direction of motion, according to the Theory of Relativity, but this is in contradiction to the previous science law that this cosmic body should be round.

2.5. Length Contraction is Independent of Time

The length contraction is, according to the Theory of Relativity, along the direction of the motion. And if the length is perpendicular on the direction of motion there is no contraction (according to the same theory).

My question is this: it looks that the length contraction is independent of time (according to the Theory of Relativity)!... i.e. if a rocket flies one second, or the rocket flies one year the rocket's along-the-motion length contraction is the same, since the contraction factor

$$C(v) = \sqrt{1 - \frac{v^2}{c^2}} \quad (74)$$

depends on the rocket's speed (v) and on the light speed in vacuum (c) only. I find this as unfair, incomplete. It is logical that flying more and more should increase the length contraction.

What about the cosmic bodies that continuously travel, do they contract only once or are they continuously contracting?

2.6. Elasticity of Relativistic Rigid Bodies?

In the classical Twin Paradox, according to the Special Theory of Relativity, when the traveling twin blasts off from the Earth to a relative velocity $v = \frac{\sqrt{3}}{2}c$ with respect to the Earth, his measuring stick and other physical objects in the direction of relative motion shrink to half their lengths.

How is that possible in the real physical world to have let's say a rigid rocket shrinking to half and then later elongated back to normal as an elastic material? It is more science fiction...

What is the explanation for the traveler's measuring stick and other physical objects, in effect, return to the same length to their original length in the Stay-At-Home, but there is no record of their having shrunk?

If it's a rigid (not elastic) object, how can it shrink and then elongate back to normal? It might get broken in this situation. This is like a science game...

2.7. Relativistic Masses vs. Absolute Masses

Similarly, the relativistic masses are considered as increasing when traveling at a relativistic speed. But if the object is rigid, doesn't it break?

And, by the way, not all masses are variable, there exist absolute masses in the universe.

2.8. Miraculous Return to the Original Length!

A rocket has length L at rest, afterwards in flying the length shrinks to $L \cdot C(v)$, then suddenly stops. According to the Special Theory of Relativity the rocket's length $L \cdot C(v)$ tacitly returns to its original length! [As the rocket was made of... plasticizer!]

2.9. Miraculous Return to the Original Mass!

Similarly, assume the rigid rocket's mass at rest is M ; after flying this mass increases to $M/C(v)$. Then, when the rocket stops, according to the Special Theory of Relativity the mass tacitly... returns to its original value (as it was elastic... rocket!).

2.10. Symmetry and Asymmetry!

In some examples, the Special Theory of Relativity considers a symmetric time dilation of two inertial reference frames.

But in other examples, such as in the GPS position system where the satellite clocks are slowed because of

the satellite velocity, it considers an asymmetric time dilation of two inertial reference frames.

As in the cause of the Twin Paradox, the time dilation was simply... abandoned!

Again an auto-contradiction.

2.11. Physical and Non-Physical Time Dilation!

The proponents of the Special Theory of Relativity contradict themselves when for some examples they say there is a physical time dilation (e.g. for particle accelerators, *GPS*, *VBLI*, *NASA*), and for other examples there is a non-physical time dilation (for interpreting the Twin Paradox).

This is a self-contradiction.

In the Absolute Theory of Relativity [2] one considers an absolute space, absolute time, absolute observer, and superluminal speeds are allowed. Superluminal phenomena do not involve traveling in time, neither objects traveling at c to having infinite masses, nor objects at superluminal speeds to having imaginary masses.

The speed of light in vacuum is not " c " in all reference frames, but varies. It depends on the speed of its frame of reference and on the observer's frame of reference.

Simultaneity does exist and it is objective in nature.

ATR has no time dilation, no length contraction, no relativistic simultaneities, and all *STR* paradoxes disappear in *ATR*.

2.12. Density Increasing?

According to the Special Theory of Relativity the mass of a moving object increases with the speed of the object, but what really increases: the object density, the object volume, or both?

Because:

$$Mass = Volume \times Density \quad (75)$$

and since the object length decreases (in the direction of movement), then should we understand that the object volume also decreases?

a) What is the *Mass-Increasing Factor* equal to?

Einstein himself disliked the concept of relativistic mass given by the formula:

$$M(v) = \frac{m}{\sqrt{1 - \frac{v^2}{c^2}}} \quad (76)$$

where m = rest mass,

and M = relativistic mass of the object moving at speed v .

- b) What is the *Volume-Increasing Factor* equal to?
- c) What is the *Density-Increasing Factor* equal to?

2.13. The Mass Paradox

The increasing in a moving frame of reference gives birth to another paradox.

If there are $n \geq 2$ simultaneous observers, each one moving with a different speed v_1, v_2, \dots , and respectively v_n with respect to the body, then the mass of the body has simultaneously n different values, $M(v_1), M(v_2), \dots, M(v_n)$ respectively in the previous formula, which is impossible and ridiculous in practice, alike in the paradoxism movement.

2.14. Another Superluminal Thought Experiment

Suppose we have two particles A and B that fly in the opposite direction from the fixed point O , with the speeds v_1 and respectively v_2 with respect to an observer that stays in the point O , as in the below figure:

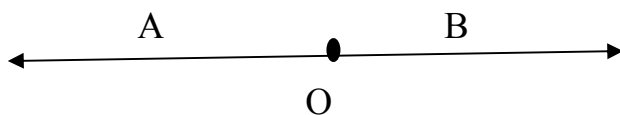

Fig. 17

Let's consider that $v_1 + v_2 \geq c$.

A) But, an observer that travels with particle A (therefore he is at rest with particle A) measures the speed of particle B as being $v = v_1 + v_2 \geq c$.

Similarly for an observer that travels with particle B : he measures the speed of particle A as also being superluminal: $v = v_1 + v_2 \geq c$.

B) If we suppose $v_1 = c$ and $v_2 > 0$, then for the observer that travels with particle A his speed with respect to observer in O is c . But, in the same time, for the observer that travels with particle A his speed with respect to particle B should be greater than c , otherwise it would result that particle B was stationary with respect to observer in O . It results that $c + v_2 > c$ for non-null v_2 , contrarily to the Special Theory of Relativity.

C) Let's recall several of Einstein's relativistic formulas:

a) *Time Dilation Formula* is:

$$\Delta t(v) = \frac{\Delta t'}{\sqrt{1 - \frac{v^2}{c^2}}} \quad (77)$$

where Δt = non-proper time,
and $\Delta t'$ = proper time.

b) Length Contraction Formula is:

$$L(v) = L' \cdot \sqrt{1 - \frac{v^2}{c^2}} \quad (78)$$

where L = non-proper length,
and L' = proper length.

c) Relativistic Momentum Formula of an object of mass m , moving with speed v , is:

$$p(v) = \frac{mv}{\sqrt{1 - \frac{v^2}{c^2}}} \quad (79)$$

d) Energy Formula of an object at rest, with rest mass m , is

$$E_0 = mc^2. \quad (80)$$

e) *The Total Energy Formula* of an object of mass m , moving at speed v , is:

$$E(v) = \frac{mc^2}{\sqrt{1 - \frac{v^2}{c^2}}}. \quad (81)$$

f) *Kinetic Energy Formula* of an object of mass m , moving at speed v , is:

$$E(v) = mc^2 \left(\frac{1}{\sqrt{1 - \frac{v^2}{c^2}}} - 1 \right). \quad (82)$$

Let's consider instead of particles two objects A and B flying in opposite directions as above.

C1) Firstly, when a clock goes at speed c with respect to any observer frame, the Special Theory of Relativity breakdown (because time dilates to infinity, length contracts to zero, relativistic momentum is infinity, the total energy and the kinetic energy are also infinite)! One actually gets the indeterminacy $1/0$.

Similarly in Lorentz Relativity for a clock going at speed c with respect to the Preferred Frame.

C2) Not talking about superluminal speeds for which, according to the Special Theory of Relativity, the non-proper time, non-proper length, relativistic momentum, total energy and kinetic energy becomes... imaginary!

D) We have hypothesized [2] that superluminal particles do exist and they do not necessitate infinite energy for traveling since the above Einstein's 2.13.C *a)-f)* relativistic formulas are valid in an imaginary space, not in the real one.

Chapter 3.
Other Paradoxes for
The Special Theory of Relativity

3.1. Opposite Thought Experiment

Let's consider the opposite case: when we have the astronaut measures the elapse interval time of the event on the earth.

It is alike the rocket stands still and the Earth is moving in the opposite direction with speed v .

The observer on earth measures the elapsed proper time:

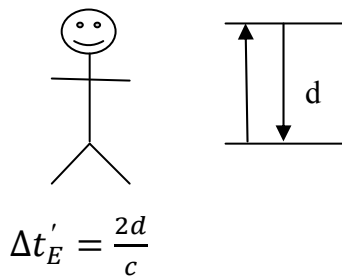

Fig. 18. Observer on Earth

where t'_E means proper time of the event on earth. The elapsed non-proper time as measured by the astronaut is showed up next.

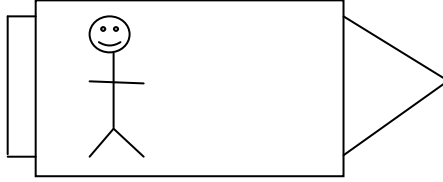

Fig. 19. Observer in the Rocket

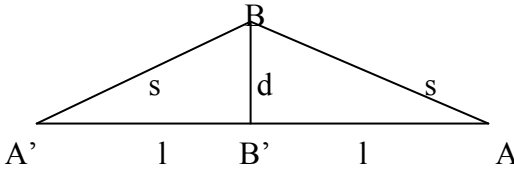

Fig. 20. Computing the Elapsed Time

Using the same calculations, with $\Delta t'_E$ and Δt_E as the elapsed proper and respectively non-proper time of the event on earth as measured by the observer on earth and respectively by the astronaut, we get:

$$2s = 2\sqrt{d^2 + l^2} = 2\sqrt{d^2 + \left(\frac{v \cdot \Delta t_E}{2}\right)^2}. \quad (83)$$

Since $2s = c \cdot \Delta t'_E$, we get:

$$c \cdot \Delta t'_E = 2\sqrt{d^2 + \left(\frac{v \cdot \Delta t_E}{2}\right)^2} \quad (84)$$

$$\text{or } c^2 \cdot (\Delta t'_E)^2 = 4d^2 + v^2 \cdot (\Delta t_E)^2 \quad (85)$$

$$(\Delta t'_E)^2 = \left(\frac{2d}{c}\right)^2 + \left(\frac{v}{c}\right)^2 (\Delta t_E)^2 \quad (86)$$

$$(\Delta t_E)^2 = (\Delta t_E')^2 + \left(\frac{v}{c}\right)^2 (\Delta t_E')^2 \quad (87)$$

$$\text{whence } (\Delta t_E)^2 [1 - \left(\frac{v}{c}\right)^2] = (\Delta t_E')^2 \quad (88)$$

$$\Delta t_E = \frac{\Delta t_E'}{\sqrt{1 - \left(\frac{v}{c}\right)^2}} \quad (89)$$

Therefore the time dilation is measured by the astronaut in the rocket. This result is contradictory with the time dilation on the earth from the previous thought experiment.

Then who is right, the observer on earth or the astronaut? Where is really the time dilation: on earth or in the rocket?

The advocates of special theory of relativity say that there is no answer to this question. They pretend that's okay. But what kind of theories are those that have undecidable propositions? Incomplete or inconsistent ones!

3.2. Odd Length Contraction

Let's denote by v_E the speed of the Earth and by v_R the speed of the rocket. Both travel in the same direction on parallel trajectories. We consider the Earth as a moving (at a constant speed $v_E - v_R$) spacecraft of almost

spherical form, whose radius is r and thus the diameter $2r$, and the rocket as standing still.

The non-proper length of Earth's diameter, as measured by the astronaut is:

$$L = 2r \sqrt{1 - \frac{|v_E - v_R|^2}{c^2}} < 2r. \quad (90)$$

Therefore Earth's diameter shrinks, which is untrue. Planet Earth may increase or decrease its diameter (volume), but this would be for other natural reasons, not because of a... flying rocket!

Also, let's assume that the astronaut is laying down in the direction of motion. Therefore, he would also shrink, or he would die!

3.3. Multi-Rocket Thought Experiment

We extend the previous example. Instead of one rocket we consider $n \geq 2$ identical rockets:

$$R_1, R_2, \dots, R_n. \quad (91)$$

Each of them moving at constant different velocities respectively

$$v_1, v_2, \dots, v_n \quad (92)$$

on parallel directions in the same sense.

In each rocket there is a light clock, the observer on earth also has a light clock. All $n + 1$ light clocks are identical and synchronized. The proper time $\Delta t'$ in each rocket is the same.

- a. If we consider the observer on earth and the first rocket R_1 , then the non-proper time Δt of the observer on earth is dilated with the factor $D(v_1)$:

$$\text{or } \Delta t = \Delta t' \cdot D(v_1). \quad (93)$$

- b. But if we consider the observer on earth and the second rocket R_2 , then the non-proper time Δt of the observer on earth is dilated with a different factor $D(v_2)$:

$$\text{or } \Delta t = \Delta t' \cdot D(v_2). \quad (94)$$

And so on. Therefore simultaneously Δt is dilated with different factors $D(v_1)$, $D(v_2)$, ..., $D(v_n)$, which is a multiple contradiction.

3.4. Two-Rockets Thought Experiment

Now let's focus on two arbitrary rockets R_i and R_j from the previous n rockets. Let's suppose, without loss of generality, that their speeds verify $v_i < v_j$.

- a. In the reference frame of the astronaut in R_i it is like rocket R_i is stationary and R_j moves with the speed $v_j - v_i$. Therefore the non-proper time interval as measured by the astronaut in R_i with respect to the event in R_j is dilated with the factor $D(v_j - v_i)$, i.e.

$$\Delta t_{i,j} = \Delta t' \cdot D(v_j - v_i), \quad (95)$$

And rocket R_j is contracted with the factor $C(v_j - v_i)$, i.e.

$$L_j = L'_j \cdot C(v_j - v_i). \quad (96)$$

- b. But in the reference frame of the astronaut in R_j it is like rocket R_j is stationary and R_i moves with the speed $v_j - v_i$ in opposite direction. Therefore, similarly, the non-proper time interval as measured by the astronaut in R_j with respect to the event in R_i is dilated with the same factor $D(v_j - v_i)$, i.e.

$$\Delta t_{j,i} = \Delta t' \cdot D(v_j - v_i), \quad (97)$$

and rocket R_i is contracted with the factor $C(v_j - v_i)$, i.e.

$$L_i = L'_i \cdot C(v_j - v_i). \quad (98)$$

But it is a contradiction to have time dilations in both rockets.

- c. Varying $i, j \in \{1, 2, \dots, n\}$ in this Thought Experiment we get again other multiple contradictions about time dilations. Similarly about length contractions, because we get for a rocket R_j , $n-2$ different length contraction factors: $C(v_j - v_1), C(v_j - v_2), \dots, C(v_j - v_{j-1}), C(v_j - v_{j+1}), \dots, C(v_j - v_n)$ simultaneously! Therefore each rocket's length is contracted in the same time in $n-2$ different ways ... which is abnormal.

3.5. Multi-Speed Thought Experiment

Suppose that the n speeds of the rockets verify respectively the inequalities:

$$0 < v_1 < v_2 < \dots < v_{n-1} < v_n < c. \quad (99)$$

The observer on rocket R_1 measures the non-proper time interval of the event in R_j as:

$$\Delta t_{1,j} = \Delta t' \cdot D(v_j - v_1), \quad (100)$$

therefore the time dilation factor is $D(v_j - v_1)$, where $j \in \{2, 3, \dots, n\}$. Thus the time dilation factor is

respectively: $D(v_2 - v_1)$, $D(v_3 - v_1)$, ..., $D(v_n - v_1)$ which is again a multiple contradiction.

Because all n rockets travel in the same time, we have a dilemma: which one of the above $n-1$ time dilation factors to consider for calculating the non-proper time as measured by the observer in rocket R_1 ?

Similar dilemma if instead of the observer in rocket R_1 we take the observer in rocket R_k , for $2 \leq k \leq n - 2$.

Also a same multiple dilemma occurs if we take into consideration each rocket's length, which gets contracted in multiple different ways simultaneously!

3.6. Dead and Alive Dilemma

Let's consider a rocket flying at the speed $0.95c$. In the rocket there are two events: Joe is born at January 1st 1930 (first event) and Joe dies at January 1st 2000 (second event). The astronaut measures the elapsed proper time:

$$\Delta t' = 70 \text{ years.} \quad (101)$$

But the observer on earth measures the elapsed non-proper time:

$$\Delta t = \Delta t'.D(0.95c) \quad (102)$$

$$= 70 \cdot \frac{1}{\sqrt{1 - \frac{(0.95c)^2}{c^2}}} \cong 224 \text{ years!} \quad (103)$$

No man on earth had ever lived that long! The following contradictions occurred:

- a. Therefore Joe died on January 1st 2000, and then he died again on January 1st 2154!
- b. Joe lived 70 years, and Joe lived 224 years too!
- c. And the funniest consequence is the fact that between January 2nd 2000 and December 31st 2153 Joe is both dead and alive! This resembles Schrodinger's cat paradox at a macro level.

3.7. Another Dilemma about Length Contraction

The distance between Earth and Alpha Centauri (which is the closest star to our solar system) is 4.3 light-years, as measured by an observer on our planet.

A particle travels from Alpha Centauri to Earth at speed $v = c$ (for example a photon) relative to the observer on Earth.

According to Einstein's Special Theory of Relativity:

$$C(v) = \sqrt{1 - \frac{v^2}{c^2}} \in [0,1] \text{ for } v \in [0, c]. \quad (104)$$

$$L = L' \cdot C(v), \quad (105)$$

where L' = proper length (which is the distance between two points measured by an observer at rest with respect to them);

L = non-proper length (distance between two points measured by an observer that is not at rest with respect to them);

v = constant speed of the moving reference frame;

c = speed of light in vacuum.

Therefore the contracted length:

$$L = (4.3 \text{ lightyears}) \cdot \sqrt{1 - \frac{c^2}{c^2}} = 0, \quad (106)$$

which is a contradictory result since the distance between Alpha Centauri and Earth is much far from zero, and even from the reference frame of the moving photon it takes to the photon 4.3 light-years to get to Earth.

3.8. The Paradox of Simultaneity: Who is the Killer?

We change Einstein's thought experiment on simultaneity in the following way. Let's consider a train moving as below from left to right:

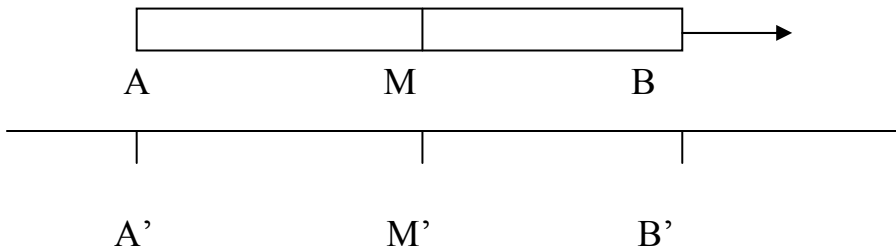

Fig. 21. The Paradox of Simultaneity

And a passenger Marcello in the middle point M of AB. A and B are the end and respectively the beginning of the train. Assume that in the train at the joints A and B there are Alex and respectively Barbara carrying each of them a gun of same caliber and bullet speed. Simultaneously, according to an observer O_t who stays at the midpoint M in the train, Alex and Barbara fatally shoot Marcello in the heart. Therefore according to observer in the train O_t , both Alex and Barbara are guilty of first degree murder, since both their bullets penetrate Marcello's heart in the same time. Therefore Alex and Barbara are both killers.

Let's consider another observer O_e on the embankment, who sits at the midpoint M' which coincides with M . Similarly on the embankment the points A' and B' coincide respectively with A and B . According to the observer on the embankment, O_e , upon Einstein's Special Theory of Relativity because the train moves from left to right, Barbara's bullet penetrates Marcello's heart and kills him before Alex. Therefore Barbara is a killer.

But Alex is not a killer, since his bullet arrives later than Barbara's, therefore Alex's bullet penetrates a dead body (not a living body). According to the observer on embankment, O_e , it's Barbara who fired the gun before Alex did.

Contradiction.

3.9. The Dilemma of Simultaneity

Let's consider two entangled particles A and B flying in the opposite directions. Let's assume they are so far away that light needs much time to travel from A to B .

If A is in state s , it instantaneously causes B to be in state s too.

We disagree with Theory of Relativity's statement that there are no influences that travel faster than light.

According to the Special Theory of Relativity we have:

- A) For an observer O_1 , traveling with particle A at time t , the event " A is in state s " occurs before the event " B is in state s ".
- B) For another observer O_2 , traveling with particle B at time t , the event " A is in state s " occurs after the event " B is in state s ".
- C) But these two observers are in contradiction with a quantum observer O_3 , which sits in the point M , where the particles started to fly from. O_3 , measuring particle A to be in state s at time t , will automatically know that particle B is in state s as well. Therefore, for the quantum experimenter O_3 the particles A and B are simultaneously in the state s .

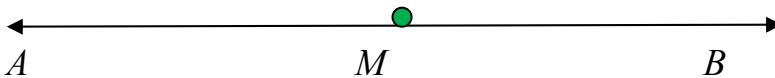

Fig. 22

3.10. Relativity of Simultaneity is Just an Appearance

In general let's consider two simultaneous events in a reference frame at rest with respect to the events.

In a moving reference frame, the same events don't look simultaneous, but this is only an appearance, a subjective impression.

In our Absolute Theory of Relativity we have no relativity of simultaneity.

3.11. Minowski's Spacetime in Heterogeneous Medium

In general, let's consider two simultaneous events in a reference frame at rest with respect to the events. In a moving reference frame the same events don't look simultaneous, but this is only an appearance.

Let's consider the locations $L_1(x_1, y_1, z_1)$ and $L_2(x_2, y_2, z_2)$ and times $t_1 < t_2$. The spacetime distance between the events $E_1 = \{I \text{ bread}\}$ at (x_1, y_1, z_1, t_1) , and $E_2 = \{I \text{ bread}\}$ at (x_2, y_2, z_2, t_2) gives the answer:

$$d^2(E_1, E_2) = c^2(t_2 - t_1)^2 - [(x_2 - x_1)^2 + (y_2 - y_1)^2 + (z_2 - z_1)^2] \quad (107)$$

Let's say that $d(E_1, E_2) = 0$, then $d(E_1, E_2)$ means that light has travelled in vacuum from location L_1 to location L_2 in the period of time $t_2 - t_1$.

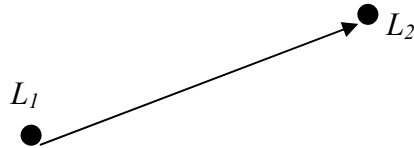

Fig. 23

But we see no connection between the fact that “I bread” and the fact that “light travels in vacuum on a distance equals to $|L_1L_2|$ ”!

Let's change this thought experiment and suppose that both locations $L_1(x_1, y_1, z_1)$ and $L_2(x_2, y_2, z_2)$ are under water, somewhere in the Pacific Ocean. Now light in the water has a smaller speed (c_w) than in vacuum, i.e. $c_w < c$. Therefore within the same interval of time $t_2 - t_1$, light travels in the water a lesser distance than L_1L_2 . Thus $d(E_1, E_2)$ has a different representation now L_1L :

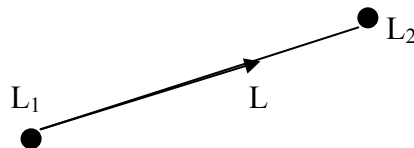

Fig.24

And, if instead of water we consider another liquid, then $d(E_1, E_2)$ would give another new result.

Therefore, if we straightforwardly extend Minkowski's spacetime for an aquatic only medium, i.e. all locations $L_i(x_i, y_i, z_i)$ are under water, but we still refer to the light speed but in the water (c_w) then the coordinates of underwater events E_w would be $E_w(x_i, y_i, z_i, c_w, t_i)$ and Minkowski underwater distance would be:

$$\begin{aligned} d_w^2(E_{w1}, E_{w2}) &= c_w^2(t_2 - t_1)^2 - [(x_2 - x_1)^2 \\ &+ (y_2 - y_1)^2 + (z_2 - z_1)^2] \end{aligned} \quad (108)$$

But if the underwater medium is completely dark it might be better to consider the speed of sound as aquatic animals used in order to communicate (similarly as submarines use sonar). Let's denote by s_w the underwater speed of sound. Then the underwater events $E_{ws}(x_i, y_i, z_i, s_w, t_i)$ with respect to the speed of sound would have the Minkowski underwater distance:

$$\begin{aligned} d_{ws}^2(E_{ws1}, E_{ws2}) &= s_w^2(t_2 - t_1)^2 - \\ &[(x_2 - x_1)^2 + (y_2 - y_1)^2 + (z_2 - z_1)^2] \end{aligned} \quad (109)$$

Similarly for any medium M where all locations $L_i(x_i, y_i, z_i)$ are settled in, and for speed of any waves W that can travel from a location to another location in this medium.

3.12. Spacetime Diagram Didn't Take into Account the Medium Composition

The problem becomes more complex when one has a heterogeneous medium and the waves travel with a speed v_1 in a part and another speed v_2 in another part, and so on [we mean the speed of light in liquids, in plastic, in glass, in quartz, in non-vacuum space in general]...

3.13. The Spacetime-Interval does not Distinguish Between Events' Nature.

If an event E_1 occurs at location $L_1(x_1, y_1, z_1)$ and time t_1 , and another event E_2 occurs at the location $L_2(x_2, y_2, z_2)$ and time t_2 , with $t_1 \leq t_2$, in the Minkowski spacetime, the squared distance $d^2(E_1, E_2)$ between them is the same and equal to:

$$\begin{aligned}
\Delta s^2 &= c^2(t_2 - t_1)^2 - [(x_2 - x_1)^2 \\
&\quad + (y_2 - y_1)^2 + (z_2 - z_1)^2]
\end{aligned}
\tag{110}$$

no matter what kind of events we have!

For example, if one has the event $E1=\{John\ drinks\}$ and the event $E2=\{George\ eats\}$, there is no connection between these two events. Or if one has two connected events: $E1=\{Arthur\ is\ born\}$ and $E2=\{Arthur\ dies\}$. There should be at least one parameter [let's call it "N"] in the above (Δs^2) spacetime coordinate formula representing the event's nature.

3.14. The Real Meaning of the Spacetime-Interval

The spacetime interval is measured in light-meters. One light-meter means the time it takes the light to go one meter, i.e. 3×10^{-9} seconds. One can rewrite the spacetime interval as :

$$\Delta s^2 = c^2(\Delta t)^2 - [(\Delta x)^2 + (\Delta y)^2 + (\Delta z)^2].
\tag{111}$$

There are three possibilities:

a) $\Delta s^2 = 0$ means that the Euclidean distance L_1L_2 between locations L_1 and L_2 is travelled by light in exactly the elapsed time Δt . The events of coordinates (x, y, z, t) in this case form the so-called light cone.

b) $\Delta s^2 > 0$ means that light travels an Euclidean distance greater than L_1L_2 in the elapsed time Δt . The below quantity in meters:

$$\begin{aligned}\Delta s \\ = \sqrt{c^2(\Delta t)^2 - [(\Delta x)^2 + (\Delta y)^2 + (\Delta z)^2]}\end{aligned}\tag{112}$$

means that light travels further than L_2 in the prolongation of the straight line L_1L_2 within the elapsed time Δt .

The events in this second case form the time-like region.

c) $\Delta s^2 < 0$ means that light travels less on the straight line L_1L_2 . The below quantity, in meters:

$$-\Delta s = \sqrt{-c^2(\Delta t)^2 + [(\Delta x)^2 + (\Delta y)^2 + (\Delta z)^2]}\tag{113}$$

means how much Euclidean distance is missing to the travelling light on straight line L_1L_2 , starting from L_1 in order to reach L_2 .

The events in this third case form the space-like region.

We consider a diagram with the location represented by a horizontal axis (L) on $[0, +\infty)$, the time represented by a vertical axis (t) on $[0, +\infty)$ perpendicular on (L), and the spacetime distance represented by an axis (Δs) perpendicular on the plane of the previous two axes. Axis (Δs) from $[0, +\infty)$ is extended down as $(-\Delta s)$ on $[0, -\infty)$.

$\Delta s = c \cdot \Delta t$ or the distance travelled by the light in the elapsed time Δt (towards an unspecified direction).

In conclusion, except for the null sub-spacetime (i. e. when $\Delta t = 0$ or $\Delta L = 0$), the real meaning of the spacetime-interval is just: how much the light travels between a location L_1 and another location L_2 in a given elapsed time Δt . The light starts at L_1 and goes on straight line towards L_2 . In the given elapsed time, the light may reach the destination L_2 , or may travel further than L_2 , or may travel less than L_2 .

That's all we get from the spacetime interval. Nothing more.

Converting time to space, or oppositely space to time, it is a non-realistic mathematical operation, outside of practice.

The spacetime diagram, which is explicitly or implicitly the graphical representation of the Special Theory of Relativity, does not describe the world, it is too abstract, artificial, and unrealistic. The spacetime metric does not reflect the reality. It is impossible to find the distance between two events to have a practical meaning.

All other interpretations of the spacetime interval, described in the literature, are pure abstractizations that unfortunately do not reflect the reality.

3.16. Relative or Absolute?

It is strange the fact that the space is considered relative and time also relative in the Theory of Relativity, but the so-called spacetime is absolute; this is an oxymoron.

Transforming time into space, or reciprocally, is just a funny concoction, but unreal.

Since the spacetime is absolute, it is not clear if anything is relative in the Theory of Relativity or not?

Chapter 4.
Dilemmas for
The General Theory of Relativity

4.1. Distinction between Clock and Time

A) In the General Theory of Relativity, it is talking about clocks that run slower or faster (depending on the gravitational field magnitude the clocks are in, or on the relativistic speeds the clocks are flying with). But, in our opinion, the clock is an instrument of measuring time, which may not run perfectly (accurately) under certain conditions (like, say, in strong electromagnetic field, in strong gravitational field, in extremely high or low temperature, etc.), but this does not mean that time itself runs slower or faster. We are referring to an absolute time, i.e. time measured not with respect to ether or non-ether, but with respect to an absolute mathematical reference frame. The absolute time for the absolute observer is the same anywhere in the universe.

Time running more slowly in a moving frame is just an impression, an appearance. The subjective time could be, but the objective one certainly not. And, by the way, the subjective times are different from an individual to another.

Several types of clocks could run at a more slowly rate in a moving frame of reference than other types of clocks; it depends on the construction material and

functioning principle of each type of clock. Again we emphasize that time is not equivalent with clock.

The clock whose construction is based on wave frequency can be influenced by the electric/magnetic/gravitational fields and by the medium velocity, energy, etc. Because the wave may propagate differently in a dense medium than in a rare medium, in a strong field than in a weak field, in a heterogeneous medium than in a homogeneous medium, or in a medium with some specific physical elements and structure than in a medium with other elements and structure.

Today we do an imperfect time measurement with our clock.

Any measurement instrument works with limited accuracy and so does the clock. If better clocks are constructed {from better material and with better mechanical/electronic/etc. functioning type}, then better measurement of the time would be. It is the clock that slows or hastens as a function of velocity, not the time slows or hastens as a function of velocity. There is a distinction between "clock" and "time".

We mean if the clocks are build based not on light pulses, but on other wave pulses and on other

functioning principle [for example a clock whose functioning is not based on waves (maybe on particles, fluids, plasma or on something else)] and from different material, then in our opinion the dilation factor and contraction factor would have a different form (i.e. the dilation factor and the contraction factor would depend on the clock type too) because various waves behave differently under a gravitational, electric, magnetic, etc. field. Also even if no field is involved, the dilation factor and the contraction factor that depend just on the inertial reference frame speed would have different formulas.

Relativists say that “gravity slows time”. This is incorrect, since actually *gravity slows clocks*, i.e. gravity slows today’s types of clocks. And one type of clock is slowed more or less than another type of clock. And, by the way, not only gravity slows clocks, but other (electric, magnetic, etc.) fields or various medium composition elements or structures may slow or even accelerate clocks that are in that medium.

The clocks used today in the satellites for the GPS position system necessitate a correction with respect to the Earth clocks. But in the future, when new types of clocks will be built based not on light impulses but on other functioning principle, then the correction of the GPS clocks would be different. Or, improving the clock

functioning by a better construction, then the correction of the GPS clocks will be less.

B) We suggest an **Experiment # 1** with another type of clock for the GPS clocks, different from the atomic clocks, and we predict different dilation and contraction factors.

In GPS there are used the cesium atomic clocks. For this clock type one second is 9,192,631,770 periods of the radiation which is corresponding to the transition between the two hyperfine levels of the ground state of the cesium 133 atom.

The light clock ticks once in every electromagnetic wave's period, but a different clock should be constructed based on waves or on particles or on plasma or on gaseous that have a different oscillation period (what about sound waves, *X-rays*, *Gamma rays*, *alpha-rays*?).

The clock rate is affected not only by the difference of the gravitational potential, the absolute velocity, the absolute kinetic energy and maybe other parameters, but also by the clock type.

4.2. Pretended Experiment on Time Dilation

In 1971 J.C. Hafele and R.E. Keating [3] transported cesium-beam atomic clocks on commercial jets, around the globe, one clock travelling east and one clock travelling west. Both clocks were in the air for 45 hours. Then the clocks were compared with another clock left on earth. The readings on the board clocks were different, within experimental errors of a few nanoseconds, from the clock on earth.

We think that this experiment did not prove that time itself was dilated [and we repeat that by time we understand the absolute (mathematically exact) time], but the time measurement tools (i.e. the travelling clocks) got distorted and they did not function perfectly.

Time dilation is rather appearance than reality; it is subjective, not objective.

Also, the experiment is inaccurate since the traveling six clocks into the commercial jets suffered accelerations (to take off) and decelerations (to land down) even if for short periods of time, in addition of changing plane periods of time [changing of positions] with very low speeds. Therefore it was neither a uniform speed nor a constant acceleration. Furthermore,

the planes did not fly at the same altitude all the time (while, according to the General Theory of Relativity at different altitudes there are different time dilations/contractions).

4.3. Limited Weak Equivalence Principle

A) The Weak Equivalence Principle is not Quite Equivalent at the Macrolevel.

We think the weak equivalence principle should be renamed as “limited weak equivalence principle” or “partial weak equivalence principle” since it is not always valid.

A1. For example: a) the lift is being stationary under a gravitational field g_p exerted by planet P, or b) the lift is in outer space under a steady acceleration.

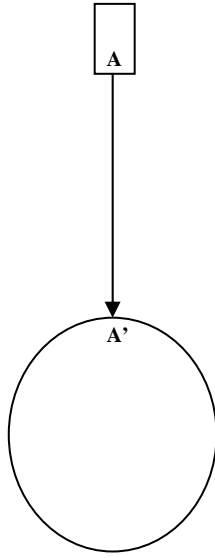

(a)

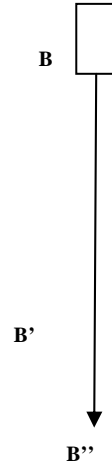

(b)

Fig. 26

If the lift in a) starting at initial speed $v_0 = 0$ is at distance $|AA'| = |BB'| = d_p$ from planet P, in planet's gravitational field of gravity g_p , then:

$$d_p = \frac{1}{2} g_p (t_p)^2 \tag{114}$$

where t_p is the time the lift needs to hit the surface of the planet P. One computes this time:

$$t_p = \sqrt{\frac{2d_p}{g_p}} \tag{115}$$

Therefore, at time $t = t_p$ there is a change of reference frame from constant acceleration to rest (with respect to planet P).

In case b), where the lift is in outer space under the constant acceleration g_p , after an elapsed time $t \geq t_p$ the astronaut realizes at point B'' that he didn't hit the planet, so he is in steady acceleration, not in a gravitational fall.

Thus the equivalence between gravitation and acceleration applies only for a period of time $t < t_p$, but doesn't apply for $t \geq t_p$.

A2. It is said that the equivalence weak principle (of gravitation and acceleration) works only on small enough region and only within a certain limited accuracy. But it is too infinitesimal in order to be (grosso modo) applied at the macrocosmos level.

But these restrictions are so strong, that many other principles may work at such small scales.

Let's retake the previous example and consider a small enough region (for example suppose the length $|AA'| = |BB'| = d_p$ is very tiny), in such that the length d_p is within a required accuracy of let's say a_p length units. It will take the two

released lifts t_p time to travel the distance d_p . One has in case a) and b):

$$0 < d_p \leq a_p. \quad (116)$$

Therefore, for a small distance d_p within a small time t_p , and under a given accuracy of a_p , the equivalence of gravitation and constant acceleration is valid.

One now changes the position of the lift, putting in a) the lift at the distance $\frac{d_p}{2}$ from the planet P 's surface, and in b) bringing the lift to the same height in outer space.

But now the equivalence principle does not apply any longer for (d_p, t_p, a_p) , since at distance $d_p' = \frac{d_p}{2}$ and consequently at time $t_p' < t_p$ the lift hits the planet surface and switches from gravitation to rest in case a), while in case b) the lift remains in steady acceleration.

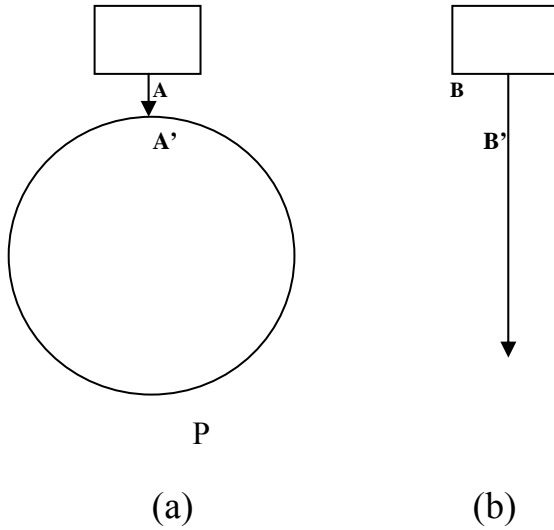

Fig. 27

Thus, one can distinguish between gravitation and acceleration.

A3. We have to shrink again the region, i.e. to take $|AA'| = |BB'| = \frac{d_p}{2}$ in order for the principle to apply.

$$\text{Let's note by } d_p^{(1)} = \frac{d_p}{2}. \quad (116)$$

But if we change again the position of lift setting it at the distance $\frac{d_p}{4}$ from the planet's surface, in case a), and the same corresponding height in

outer space, for case b), we get a similar conclusion that the equivalence principle does not apply for $(d_p^{(1)}, t_p^{(1)}, a_p^{(1)})$ – where $t_p^{(1)}$ is the time the two released lifts travel the distance $d_p^{(1)}$ the first one to hit the planet's surface. One can repeat this process infinitely many times:

$$\lim_{n \rightarrow \infty} d_p^{(n)} = \lim_{n \rightarrow \infty} \frac{d_p}{2^n} = 0 \quad (117)$$

$$\text{and } \lim_{n \rightarrow \infty} t_p^{(n)} = 0 \quad (118)$$

until the lift stays still on the planet's surface, although under the planet's gravitational field, in case a), while in case b) the lift is in outer space, at the same height, but under steady acceleration.

One can distinguish again between the two cases (standing still and constant acceleration).

A4. Another example.

- a. A man in the lift let an object falls down under gravity g_p of the planet P. It is directed towards the planet P center O_1 .

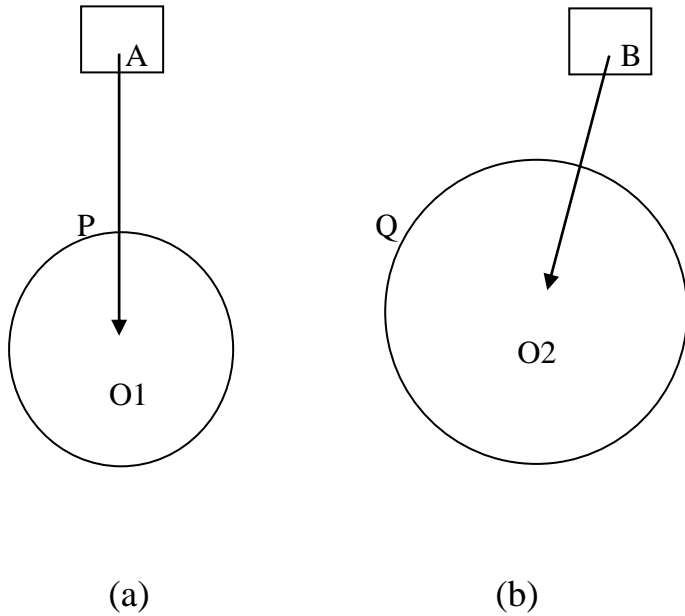

Fig. 28

- b. Another man in a rocket accelerating towards planet Q let a similar object fall down from the same altitude as the man in the lift. The object is directed towards the planet Q center O₂. The gravitation g_Q of planet Q is stronger than g_P , but the rocket fires its engines and manages to travel down towards planet Q with acceleration g_P (as the lift's gravitation). Yet, the directions AO₁ and BO₂ are not parallel

(they have different inclinations/slopes)
neither have equal lengths.

A5. Another example: a) the lift is being stationary under a gravitational field g_p exerted by planet P, but in a lateral way as in the below figure, or b) the lift is in outer space under a steady acceleration.

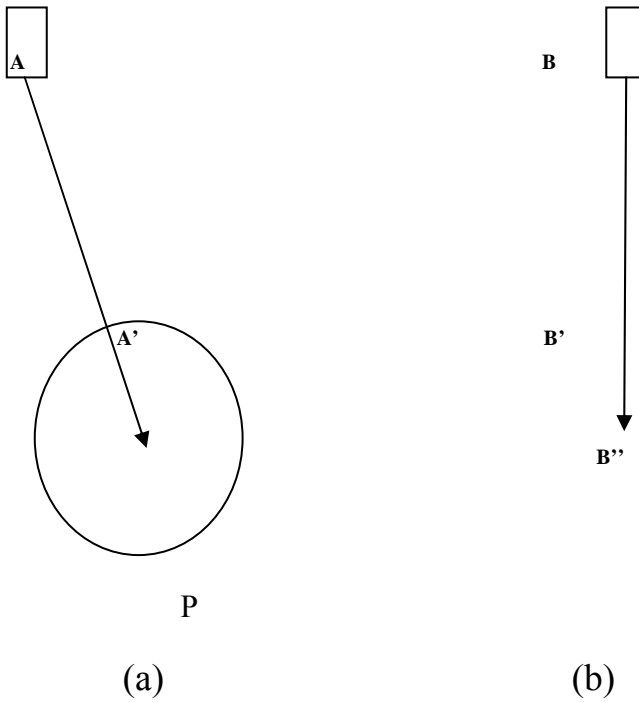

Fig. 29

In this case the lengths $|AA'|$ and $|BB'|$ are neither parallel nor equal. Therefore the objects dropped from A and respectively from B, under the same acceleration {i. e. of the planet's gravitation in a) and of the rocket's acceleration in b)}, will need different elapse times to get to the same level A' (respectively B').

B) Weak Equivalence Principle at the Quantum Level?

Would the equivalence principle work for quantum gravity?

We mean is quantum gravity equivalent to a quantum acceleration?

4.4. Constant Acceleration is not Equivalent with Heterogeneous Gravity

Gravity is not always equivalent with acceleration.

A frame in a constant acceleration is considered equivalent with a homogeneous gravitational field of the same magnitude; but most real gravitational fields are heterogeneous fields.

4.5. Other Questions with Respect to the Weak Equivalence Principle

4.4.1. A disc rotating at high speed will exert out-of-plane forces resembling an accelerating field. Is the principle of equivalence also applicable for this process?

4.4.2. Will someone inside an elevator in free-fall and rotating around its vertical centre, feel a gravitational force? Or will he feel a gravitational force larger than what equivalence principle requires? Does the equivalence principle remain applicable here?

4.4.3. An airplane flies at an altitude of 1 km. The co-pilot drops an elevator-room without a passenger inside it. After one second has elapsed, the co-pilot drops four grenades in the direction of the freely-falling elevator's path. The question: Will the grenades reach the elevator before it reaches the ground? If no, why? If yes, which grenade? How will the air resistance influence the outcome?

4.6. Very Limited Strong Equivalence Principle

The *Strong Equivalent Principle*, which asserts that not only motion but all physical behavior is the same under gravity as for acceleration, is also very limited.

4.7. Relativity on Rotating Frames

- A) How would the Theory of Relativity be extended for rotating frames with constant velocity? {Is a uniform rotation equivalent to a uniform linear motion?}
- B) But for rotating frames with constant acceleration?
- C) And more general on rotating frames with non-constant velocity or non-constant acceleration?

4.8. The Paradox of Special vs. General Theory of Relativity

Two clocks $C1$ and $C2$ are synchronized on the earth. Then clock $C2$ is flying with a uniform speed at an altitude $h > 0$ above the earth.

- A) According to the Special Theory of Relativity there is symmetry of time dilation between $C1$ and $C2$.
- B) But, according to the General Theory of Relativity, there is an asymmetry of time between $C1$ and $C2$, since the clock $C1$ is running slower down in the gravitational field than the clock $C2$ which is running faster at a higher altitude.

4.9. Conflicting of Special vs. General Theory of Relativity

In the Special Theory of Relativity, the time dilation resulted from the relative motion was a symmetrical phenomenon for both observers (not even knowing which observer was indeed moving);

while in the General Theory of Relativity, the gravitational effect on clocks is asymmetrical for the two observers, they both knowing which one is lower down and respectively higher up in the gravitational field, and they both agreeing that the clock runs slower lower down and respectively faster higher up in the gravitational field.

4.10. A) Redshift and Blueshift are due to the Medium Composition

A) The *redshift* is the shift from shorter wavelengths towards longer wavelengths [or from higher wave frequency to lower wave frequency].

And, reciprocally, the *blueshift* is the shift from longer wavelengths towards shorter wavelengths [or from lower wave frequency towards higher wave frequency].

The General Theory of Relativity asserts that the redshift and blueshift are entirely due to the *Doppler's Effect*, which is caused by the motion of light source: if the source is moving away from the observer the

frequency received is lower [redshift], but if the source is moving towards the observer the frequency received is higher [blueshift].

But Doppler's Effect itself is actually an appearance to a Subjective Observer, because the frequency is the same all over (if one considers the Absolute Observer).

We believe that the redshift and blueshift are not entirely due to the Doppler's Effect, but also due (as in the light bending) to the medium composition (medium that could be formed by waves, particles, plasma, dust, gaseous, fluids, solids, etc.), to the medium density, to the medium heterogeneity, to the medium structure, and to the electromagnetic and gravitational fields contained in that medium that may interfere with the light that passes through. Or it could be an *optical phenomenon* (as the stick half in water and half in air looks bended at the water's surface).

B) A suggested **Experiment # 2** should be done by changing the medium's composition elements (particles, fields, etc.), structures, densities, heterogeneities, etc. (but keeping the other data fixed, i.e. the relative speeds of the wave and the observer as well as the wave's traveling distance stay the same). By changing the medium the light passes through, one should get different degrees of redshifts/blushifts.

4.11. Not Gravitational Lensing, but Medium Lensing

According to the General Theory of Relativity the gravity curves the spacetime and everything overthere follows a curved path.

The space being curved near massive cosmic bodies is just a metaphor, not a fact.

We dough that gravity is only geometry. {Actually, there are many theories or attempts of explaining the gravity, none of them yet completely satisfactory.}

The deflection of light (Gravitational Lensing) near massive cosmic bodies is not due because of a “curved space”, but because of the medium composition (medium that could be formed by waves, particles, plasma, dust, gaseous, fluids, solids, etc.), to the medium density, to the medium heterogeneity, and to the electromagnetic and gravitational fields contained in that medium that light passes through. This medium can deviate the light direction, because of the interactions of photons with other particles.

The space is not empty, as Theory of Relativity says. It has various nebulae and fields and corpuscles, etc.

Light bends not only because of the gravity as the Theory of Relativity asserts. By the way, it has been later discovered that Sir Arthur Eddington’s data from year 1919, that pretended validating Einstein’s prediction, was fabricated...

Light bends because of the medium gradient and refraction index, similarly as light bends when it leaves

or enters a liquid, a plastic, a glass, or quartz. The inhomogeneous medium may act as an optical lens such that its refractive index varies in a fashion, alike the *Gradient-Index Lens*.

We talk about a **Medium Lensing**, which means that photons interact with other particles in the medium. For example, the interaction between a photon of electromagnetic radiation with a charged particle (let's say with a free electron), which is known as *Compton Effect*, produces an increase in the photon's wavelength by the amount $\Delta\lambda$, where:

$$\Delta\lambda = (2h/m_0c)\sin^2\left(\frac{1}{2}\varphi\right) \quad (119)$$

with h = Planck constant;

m_0 = rest mass of the particle;

c = speed of light;

φ = the angle between the directions of the scattered photon and the direction of the incident photon;

$$\text{and } h/m_0c = \lambda_c \quad (120)$$

is the *Compton wavelength*.

In the *Inverse Compton Effect* the low-energy photons gain energy because they were scattered by much-higher energy free electrons.

4.12. Medium's Properties

The longer is the medium corridor a wave passes through, the larger is the probability of the medium redshifting/blushifting and lensing that wave.

The wave may interfere or superposition with other medium's waves.

Medium's Properties that play an important role:

- dynamicity of the medium;
- medium and wave interactivity;
- medium's electrostatic/magnetostatic/gravitational potentials at each point in the medium that the interest wave passes through;
- medium's degree of refractivity and degree of diffractivity;
- medium's selectivity (ability to discriminate against the wave of interest that has a different frequency);
- medium's energy density;
- medium's scattering property, i.e. the deflection of light from the main direction caused by medium's fine particles of gaseous, liquid, or solid matter;
- medium's magnetic flux density and direction (permeability/reluctivity);
- medium's transmissivity (ability to transmit radiation);
- medium's diffusivity (the rate ay which is diffused the heat through the medium);
- medium's vibrations and oscillations;
- medium's sensitivity to waves and particles;
- the degree by which medium's solids and fluids mix with one another (diffusion);

- medium's distorticity (i.e. the magnitude the medium fail to accurately reproduce at its output the properties of the input);
- medium's potential gradient (electric potential's rate of change);
- temperature, pressure, volume, and especially chemical reactions that occur in the medium;
- medium's degree of adiabaticity (the quantity of heat that enters or leaves the medium);
- divergency/convergency of the medium's flux in a vector field;
- existence/nonexistence of allotropes (substances in two forms that differ in physical properties) in the medium;
- degree of coercivity of medium's magnetic field if any;
- medium's compressibility/incompressibility;
- medium's viscosity/fluidity;
- medium's elasticity/inelasticity;
- medium's conductivity/resistivity;
- medium's radiation (degree of emissivity);
- medium's symmetry or asymmetry;
- medium's degree of response (impedance/admittance);
- medium's degree of entropy;
- etc.

As one can see above, the redshifting/blushifting and lensing are much more complex than the simple Doppler's apparent Effect or only the Gravitational Lensing (therefore, this questions Hubble's Law). Not all of these properties would have a much impact but

some of them amplify the redshifts/blushifts and light bending.

4.13. The Frame Dragging is just the Classical Vortex

The spacetime being “dragged” by a massive cosmic body (which is called “frame dragging” in the General Theory of Relativity) is just the classical vortex the massive cosmic body generates when moving – vortex created by wind, particles, dust, fields etc. of the medium.

Again, by medium we mean the natural space composition, i.e. the physical elements the natural space is formed of.

Chapter 5.
Open Questions and Remarks

5.1. Controller is not Aware

Let's assume that the controller is not aware of the flying rocket. Then does it still exist a time dilation for the controller and space contraction for the astronaut? The relativists again say that it is "meaningless" (undecidable). But what kind of theories give birth to undecidable propositions? Incomplete or inconsistent theories.

5.2. Distorted Bodies

By space contraction, the bodies are distorted, i.e. the proportions are not kept and angles in general are not invariant (only the right angles formed by body's edges perpendicular on other body edges along the motion are invariant). For the right triangle:

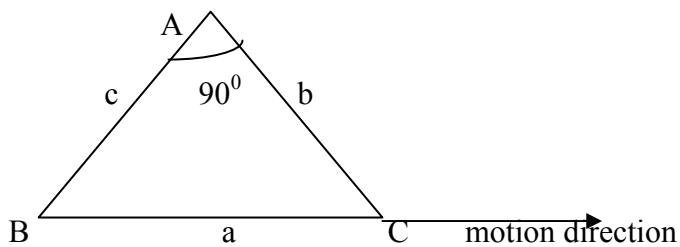

Fig. 30

$a^2 = b^2 + c^2$ with $\sphericalangle A = 90^\circ$, but after lengths' contraction, the edges become:

$$a' = a \cdot C(v) \quad (121)$$

$$b' = b \cdot OC(v, \theta) \quad (122)$$

$$c' = c \cdot OC(v, 90^\circ - \theta) \quad (123)$$

But in general

$$(a')^2 \neq (b')^2 + (c')^2, \text{ so } \sphericalangle A' \neq 90^\circ, \text{ or } \sphericalangle A' \neq \sphericalangle A. \quad (124)$$

5.3. Pure Gravitational Field

The General Theory of Relativity asserts that it is possible to have a pure gravitational field, without any matter at all, which acts as a source for itself.

Then the following questions arise: What does happen to the cosmic travelling small, medium and massive objects to the atomic and sub-atomic particles in this pure gravitational field? Do they fall to the bottom of the pure gravitational field, and do they eventually form a compact cosmic body whose own gravitational field is this pure gravitational field?

Does it exist any experiment proving that gravity influences light speed or light trajectory? Does indeed gravity attract light?

{The light escaping or not a gravitational field in General Theory of Relativity or in a Black Hole can be considered if it has been experimentally proven that light is influenced by gravity.}

Also, if *mass produces gravity* and *gravity produces mass*, then it results that pure gravitational field will produce/generate some mass. How? Will objects, dust, particles be attracted in and condensed into a compact body inside of this pure gravitational field?

5.4. Other Pure Fields?

As a generalization of the previous Pure Gravitational Field, is it possible to have a Pure Magnetic Field, or Pure Electric Field, or Pure Electromagnetic Field, etc. without matter in its proximity?

5.5. Conservation Law for Gravity?

A) If a planet explodes or is destroyed, what does happen to the planet gravitational field? Does it disappear? Does there exist a conservation law for gravity?

For example: If a planet is split into $n \geq 2$ parts, will the planet gravitational field be also split among these n parts?

Is the gravitational field conserved or transformed? If transformed, would it be into energy?

5.6. What Happens to the Curved Space around a Massive Object that has been Destroyed?

A) According to the General Theory of Relativity the space is curved around a massive object. Then, after the planet explodes (due to internal forces) or destroyed (because of external forces) does the space around it still remain curved or does it straighten back to flat?

How would the disappearance of a planet impact the other planets? Will its orbit be occupied by another cosmic object that might be forming from residues that fall into this orbit?

B) If space is curved around a star and forms tracks that planets travel following these tracks as rail-roads, why not other (small, or

medium, or massive) objects are falling into these tracks and traveling around the star on the same orbits?

5.7. What Happens to the Planets that Orbit a Star that has Died?

If a star explodes or is destroyed or dies, what happens to the planets that orbit it? Will they continue to orbit by inertia the point where the star used to be? For how long time?

5.8. Is Time an Entity without Beginning and Ending?

Is there a beginning and ending of time? Or is the time an entity without ending or beginning?

We dough the Big Bang Theory that asserts a *creatio ex nihilo* of the Universe...

If it was a point in the Big Bang that exploded, where did this point come from? What was before that point?

5.9. Creating Gravity

Massive cosmic bodies create gravity. Is there a bound for such cosmic bodies (depending on mass, volume, density, and may be position) starting from which cosmic bodies create gravity, while below that bound they don't create gravity?

5.10. Not All Physical Laws are the Same in All Inertial Reference Frames

A. *Different Inertial Values for a Moving Object.*

The laws of physics are not the same in all directions for a moving object according to the Special Theory of Relativity,

since lengths which are oblique to the direction motion are contracted with the oblique-factor $OC(v,\theta)$,

while the lengths along the motion direction are contracted with a different factor $C(v)$,

but lengths that are perpendicular to the direction motion are not contracted at all;

which require different inertia values for the moving object.

B. *There are universal constants that are not quite “constant” throughout the universe.*

C. Would it be possible to get physical systems where the energy conservation law doesn't hold?

D. Would it be possible to get physical systems where the Earth's physical laws are invalid?

Maybe our laws are only local, but non-local laws may apply in other galaxies.

We believe on other planets, or in other solar systems, galaxies the laws of physics are not the same.

The Laws of Physics are influenced by the medium composition, velocity, etc. of the frame of reference.

5.11. Back in Time?

If the time runs faster at the top of a gravitational field than at the bottom of a gravitational field, then sending a signal from top down could be like a message sent back in time, which is unrealistic!

5.12. Wormholes do not Exist in a Real World

The Wormholes were predicted by the Theory of Relativity [through Hermann Weyl in 1921 and John

Archibald Wheeler in 1957], but the Wormholes permit time travel (that is unrealistic) and violate the causality.

The Wormholes can be valid in an imaginary space only.

5.13. Newton's Physics or Einstein's Metaphysics?

Is it any threshold of the speeds, let's say $\alpha \cdot c$, with $\alpha \in [0,1]$, such that for the speeds $0 \leq v \leq \alpha \cdot c$ we apply Newton's Physics, and for the speeds $v > \alpha \cdot c$ we apply Einstein's Special Relativity?

The proponents of Special Relativity say that Einstein's Velocity Addition Formula

$$v_1 + v_2 = \frac{v_1 + v_2}{1 + \frac{v_1 \cdot v_2}{c^2}} \quad (125)$$

prevails for any speeds. But this formula fails for superluminal speeds.

5.14. Neither $2c$ is a Speed Limit

We do not agree with the *Lorentz Relativity* and the *Lorentz Ether Relativity* that support superluminal speeds up to a limit of $2c$, although the absolute velocities are added using normal arithmetic in these two Relativities. We think there can be constructed speeds that overpass $2c$ as well.

5.15. Subjective Dilation-Time

For two observers, in two moving referential frames, each one sees a time dilation for the other (time-dilation symmetry). But this is clearly a *subjective time dilation*, not an *objective time dilation*.

These symmetric time dilations cannot be simultaneously done in practice; it is absurd.

5.16. Subjective Local Time vs. Objective Global Time

The proponents of the Theory of Relativity assert that the so-called black hole is so powerful, that even the time itself is brought to a stop. But this looks very much as science fiction, since the objective time goes on anyway.

5.17. Relative vs. Absolute Space and Time

Einstein says that there is no absolute space or absolute time. But we argue that we can mathematically consider an absolute space and absolute time, in order to eliminate all paradoxes and anomalies from Theory of Relativity.

Relative Space and Time are referring to Subjective Theory of Relativities, while Absolute Space and Time are referring to Objective Theory of Relativity {see the Absolute Theory of Relativity [2]}.

The observers are relative, subjective indeed, but mathematically there can be considered an *Absolute Observer*. {There are things which are absolute.}

5.18. Contraction of the Universe?

If the Universe is expanding (therefore moving), according to the Special Theory of Relativity it should be contracting along the moving direction.

Continuously moving bringing continuously contracting?... therefore until getting back to a point (as the supposed original Big Bang)?

5.19. The Michelson-Morley Null Experiment was not quite Null

While the establishment interpreted the result of Michelson-Morley Experiment as null, many other researchers considered it as not quite null.

The supposed Michelson-Morley *Null* Experiment instigated the physical theorists to invent Relativity Theories with abnormal/non-practical length contraction, time dilation, mass increase, etc.

5.20. Variable Speed of Light in Vacuum

The speed of light in vacuum is not invariant as seen by different frame of reference observers. It depends on the light source and its frame of reference.

Its addition with other speeds follows the classical law of velocity addition.

5.21. Instantaneous Acceleration?

In all paradoxes involving movement it is supposed that something goes at a constant uniform speed. One assumes a so-called "instantaneous acceleration": it is considered the ideal case when jumping from zero velocity directly to velocity v , and similarly jumping

back from v to zero velocity when stopping. Therefore, many Thought Experiments are just approximations, no matter how large is the segment of constant speed with respect to the acceleration segment, because one cannot get to the constant speed without starting from zero speed.

5.22. Where the Extra-Mass Comes from?

Relativistic Mass increases with speed according to the Theory of Relativity. But an elementary question arises: where the extra-mass comes from?

Also, how the extra-mass was produced?

Assuming that the initial mass has a charge, then does the increased mass have the same charge?

5.23. Space is Not Curved

For a $1D$ (one-dimensional)-curve one can see its curvature in a $2D$ -space.

For a $2D$ -surface one can see its curvature in a $3D$ -space.

But how to see the curvature of a $3D$ -body, since there is no $4D$ -space in the real world? {We do not talk about

the spacetime which has dimension four, since the spacetime is unreal.}

Some physicists assume the possibility of hidden dimension(s), but such things have not yet been found.

Since there is no $4D$ -space in the real world (time is not taken into consideration since it is an independent entity), the $3D$ -space cannot be curved.

5.24. Black Hole is an Imaginary Cosmic Body

Since the Black Hole purely aroused from the mathematical solution by Schwarzschild (and Hilbert) to the Einstein's Field Equations, and because Einstein's Field Equations do not describe the real universe, the Black Hole is so far just an imaginary cosmic body (or the notion of "black hole" has to be redefined).

While the Black Body, for example, is a theoretical ideal (not entirely realized in practice, but only approximated...), which has not at all the power of reflecting light, the relativists consider the Black Hole as a physical object (!)

5.25. Fact or Mathematical Artifact?

Interestingly, even the Black Hole's center, which is a point of infinite density and zero volume (which looks fantastic!), is considered a real physical entity, although clearly it is a mathematical artifact.

5.26. What is the Maximum Discovered Density in the Universe?

Since no experiment has ever shown a density being infinite for a physical object in the universe, our question is what would be the maximum discovered density in the universe? Would it be possible to create any given density?

5.27. Maximum Strongest Fields?

- a) What is the strongest gravitational field in the universe?

What would be the maximum gravitational field to be produced in the laboratory?

- b) Similarly, what is the strongest electric field in the universe?

What would be the maximum electric field to be produced in the laboratory?

c) Similarly, what is the strongest magnetic field in the universe?

What would be the maximum magnetic field to be produced in the laboratory?

5.28. How to Compute the Mass of a Singularity Point?

Let's consider the Black Hole's singularity that occurs for $r = 0$ in

$$g_{00} = \left(1 - \frac{2Gm}{c^2 r}\right)^{1/2} \quad (126)$$

where

m = mass of the spherically cosmic body;

G = gravitational constant of the body;

r = distance from the cosmic body to the clock;

c = speed of light in vacuum;

and represents, according to the relativists, an *infinitely dense point-mass* that is at the center of the Black Hole.

It is not clear how to compute the mass of this singularity, since

$$\begin{aligned}
 \text{Mass} &= \text{Volume} \times \text{Density} = \\
 &= 0 \times \infty = 0, \infty, \text{ or another value?}
 \end{aligned}
 \tag{127}$$

Another singularity occurs for

$$r = \frac{2Gm}{c^2} \tag{128}$$

in

$$g_{11} = \frac{-1}{\left(1 - \frac{2Gm}{c^2 r}\right)^{1/2}} \tag{129}$$

And it is considered by relativists as Schwarzschild radius of a Black Hole, or the radius of the event horizon.

5.29. Mute Body

What about a cosmic body whose escape speed would be greater than the speed of sound (instead of the speed of light)? Therefore, no sound would come out from that body, so it would be labeled as “mute body”!

5.30. Travel in Time is Science Fiction

Relativists also support the travel to the past and travel to the future. But these are not possible in reality (see the *traveling time paradoxes*, where travelers change the past or the future). Because, for example, if somebody has changed the past, we don't know which one was the real past, the original one or the changed one? It is not possible to have two or pasts!

Relativists conclude that it is possible to travel in the future in the real world, because when we board an aircraft, for example, we are moving with respect to those who remain behind, therefore our time will pass slowly compared to those who remain behind. But this is an illusion since according to the absolute observer time is the same in moving or staying reference frame. Maybe the biological or subjective time changes, but not the objective time.

5.31. Time Coming to a Halt?

According to the relativists, when

$$\left(1 - \frac{2Gm}{c^2 r}\right)^{1/2} = 0 \quad (130)$$

the time would come to a halt, because Schwarzschild's solution to Einstein's Field Equations for a spherically symmetric body shows that the rate of the clock is reduced by the factor

$$\left(1 - \frac{2Gm}{c^2 r}\right)^{1/2}. \quad (131)$$

But in the real world this is fantasy!

5.32. No Wormholes

Therefore, Einstein-Rosen Bridge, as a solution to Einstein's Field Equations, which allegedly connects different regions of the universe and just could be used as a time machine, is just fictitious.

5.33. Escape Velocity

The escape velocity from an alleged Black Hole is

$$c = \sqrt{2Gm / r}. \quad (132)$$

But in the future technology, it would be able to accelerate a photon inside of a Black Hole's event horizon to have it travel at a speed greater than c . Also the superluminal particles would escape.

Thus the Black Hole would not be black any longer.

5.34. What about more Cosmic Bodies?

Schwarzschild considered only one cosmic spherical body when solving Einstein's Field Equations. But, what about more cosmic bodies (or more Black Holes)?

5.35. No Universe Expansion since Earth is not the Center of the Universe

Hubble's Law (1929) says that all galaxies are moving away from Earth at a velocity which is directly proportional to their distances from Earth. It presumes that, due only to the velocity at which the galaxies are moving away from the Earth, one has the redshift.

Yet, it looks that Hubble's Law is not followed by the *quasars*, which have big redshifts, emit large amounts of energy and lie behind our Milky Galaxy.

According to Hubble's Law, the *universe is expanding*, and the velocity of a receding galaxy with respect to our Earth is

$$v = H_0 \cdot D \quad (133)$$

where H_0 = Hubble's Constant, and H_0 is between 50-100 (typically 70) km/sec per megaparsec (3.26 million light-years);

and D = distance from the galaxy to the Earth.

But, if the galaxies recede with respect to the Earth at a velocity proportional to their distances from Earth, it involves that our Earth is, or is becoming, the center of the universe.

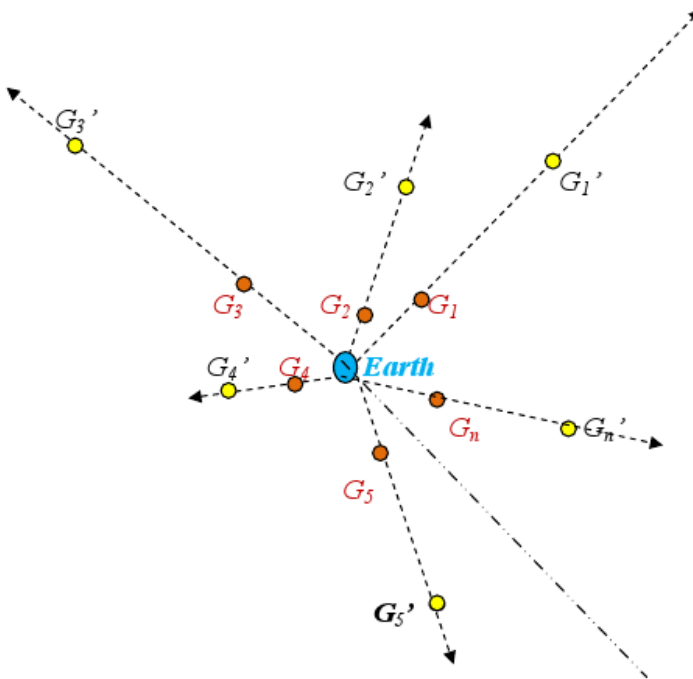

Fig. 31. Diagram of Allegedly Expansion Universe

In the above diagram, the Earth stays in the expansion center, and $G_1, G_2, \dots, G_n, \dots$ are galaxies, while $G_1', G_2', \dots, G_n', \dots$ are respectively their expansion positions after a certain t_1 . The diagram is continuously extended in all directions, according to Hubble's Law, and after times t_2, t_3, \dots the corresponding new positions of the galaxies would respectively be $G_1'', G_2'', \dots, G_n'', \dots$ at time t_2 , then $G_1''', G_2''', \dots, G_n''', \dots$ at time t_3 , etc. the galaxies getting further and further from the Earth, i.e. pushing the Earth closer and closer to the center of all galaxies.

Even if Earth was not the center of the universe at the alleged Big Bang, after such permanent expansion of the universe with respect to the Earth, it would result that the Earth is in process of becoming the center of the universe... But the experiments do not show that.

5.36. White Holes?

From Einstein's Field Equations one can also deduce the so-called White Holes, which are opposite to the Black Holes, and their property is that things are spewing out from the White Holes. But then if all matter is spewing out, as in antigravity, then the White Hole would contain no matter at all. Will it then remain only as a pure antigravity field? Very strange cosmic object...

5.37. Scientific Perversity

If data obtained from any experiment or application matches the Theory of Relativity, then that type of data is considered covered by and supporting the Theory of Relativity.

But, if such data does not match the Theory of Relativity predictions, then it is considered as not covered by the Theory of Relativity, and therefore (!) not contradicting the Theory of Relativity.

All pretended tests of General Relativity can be solved without using the General Relativity.

That's why it became a break in the developing of science since every experiment and theory has not to be in conflict with Einstein's Theory of Relativity, which became a fictitious theory producing confusions, ambiguities and self-contradictions. Unfortunately the optical illusions were taken for realities...

An untrue hypothesis that "the speed of light is constant in vacuum in all reference frames (no matter with what uniformly moving speeds!) in all directions" generates a theory whose consequences are weird, non-common sense, even anti-logical and unrealistic. From invalid

postulates one gets ridiculous conclusions like in comic stories.

The physicists dream too much and suddenly they invent fantasy theories and require us to take them for granted.

Theories that produce fantastic consequences are fantastic themselves.

Einstein's Relativity is more a science game than reality.

Lorentz Transformation is just a distortion factor of the reality.

The *Gravitational Waves* have not been discovered.

Einstein's Field Equations and *Pseudotensor* are valid in an imaginary space only. There is no proof that Einstein's Field Equations do not violate the common law of conservation of energy and momentum.

Other times, in order to bridge the gap between the Theory of Relativity and experimentally found data, all kind of strange things and ideas are invented. Instead of fitting the theory to better describe the reality, the reality is distorted in order to fit into the theory!

5.38. Comparison of Paradoxes of Many Relativities

Are all *Special Theory of Relativity* paradoxes also *Lorentz Relativity* paradoxes, or *Lorentz Ether Theory* paradoxes, or *Preferred Frame Theory Relativity* paradoxes?

Maybe not, since in the last three Relativity Theories there is asymmetry, not symmetry as in *Special Theory of Relativity*.

References:

1. A. Einstein, *On the Electrodynamics of Moving Bodies*, *Annalen der Physik*, **17**, 891-921, 1905.
2. F. Smarandache, *Absolute Theory of Relativity & Parameterized Special Theory of Relativity & Noninertial Multirelativity*, Somipress, Fès, 92 p., 1982.
3. J. C. Hafele and R. E. Keating, *Around the World Atomic Clocks: Relativistic Time Gains Observed*, *Science* 168, July 14, 1972.
4. F. Smarandache, "There is No Speed Barrier in the Universe," *mss.*, Liceul Pedagogic Rm. Vâlcea, Physics Prof. Elena Albu, 1972.

5. D. Bohm, "The Paradox of Einstein, Rosen, and Podolsky," *Quantum Th.*, pp. 611-623, 1951.

Following the Special Theory of Relativity, Florentin Smarandache generalizes the Lorentz Contraction Factor to an **Oblique-Contraction Factor**, which gives the contraction factor of the lengths moving at an oblique angle with respect to the motion direction. He also proves that relativistic moving bodies are distorted, and he computes the **Angle-Distortion Equations**.

He then shows several paradoxes, inconsistencies, contradictions, and anomalies in the Theory of Relativity.

According to the author, **not all physical laws are the same in all inertial reference frames**, and he gives several counter-examples. He also supports **superluminal speeds**, and he considers that **the speed of light in vacuum is variable**.

The author explains that the redshift and blueshift are not entirely due to the Doppler Effect, but also to the **medium composition** (i.e. its physical elements, fields, density, heterogeneity, properties, etc.).

He considers that **the space is not curved** and the light near massive cosmic bodies bends not because of the gravity only as the General Theory of Relativity asserts (Gravitational Lensing), but because of the **Medium Lensing**.

In order to make the distinction between “clock” and “time”, he suggests a **first experiment** with a different clock type for the GPS clocks, for proving that the resulted dilation and contraction factors are different from those obtained with the cesium atomic clock; and a **second experiment** with different medium compositions for proving that different degrees of redshifts/blushifts would result.